

DS-495

Revision of SSR-6, 2012 Edition

Regulations for the Safe Transport of Radioactive Material

Comparative table between 2012 Edition and first draft of  
20xx Edition

[Comment: all numbering of paras and references to paras should be checked  
later throughout document.]

20xx Edition

PREFACE

CONTENTS

SECTION I. INTRODUCTION . . . . . 1  
Background (101–103) . . . . . 1  
Objective (104–105) . . . . . 2  
Scope (106–110) . . . . . 2  
Structure (111) . . . . . 4

SECTION II. DEFINITIONS (201–249) . . . . . 5

SECTION III. GENERAL PROVISIONS . . . . . 15  
Radiation protection (301–303) . . . . . 15  
Emergency response (304–305) . . . . . 15  
Management system (306) . . . . . 16  
Compliance assurance (307–308) . . . . . 16  
Non-compliance (309) . . . . . 16  
Special arrangement (310) . . . . . 17  
Training (311–315) . . . . . 17

SECTION IV. ACTIVITY LIMITS AND CLASSIFICATION . . . . . 21  
General provisions (401) . . . . . 21  
Basic radionuclide values (402) . . . . . 21  
Determination of basic radionuclide values (403–407) . . . . . 21  
Classification of material (408–420) . . . . . 47  
Classification of packages (421–433) . . . . . 51  
Special arrangement (434) . . . . . 55

SECTION V. REQUIREMENTS AND CONTROLS □  
FOR TRANSPORT . . . . . 57  
Requirements before the first shipment (501) . . . . . 57  
Requirements before each shipment (502–503) . . . . . 57  
Transport of other goods (504–506) . . . . . 58  
Other dangerous properties of contents (507) . . . . . 59  
Requirements and controls for contamination and □  
for leaking packages (508–514) . . . . . 59

Requirements and controls for transport of excepted packages□ (515–516) . . . . .	60
Requirements and controls for transport of LSA material and□ SCO in industrial packages or unpackaged (517–522) . . . . .	61
Determination of transport index (523–524). . . . .	62
Determination of criticality safety index for consignments,□ freight containers and overpacks (525) . . . . .	63
Limits on transport index, criticality safety index and□ <del>radiation levels</del> <u>dose equivalent</u> <u>dose equivalent rate</u> for packages and overpacks (526– 528) . . . . .	64
Categories (529) . . . . .	64
Marking, labelling and placarding (530–544). . . . .	65
Consignor’s responsibilities (545–561) . . . . .	73
Transport and storage in transit (562–581) . . . . .	79
Customs operations (582) . . . . .	86
Undeliverable consignments (583) . . . . .	86
Retention and availability of transport documents by carriers (584–588) . . .	86

SECTION VI. REQUIREMENTS FOR RADIOACTIVE□  
MATERIAL AND FOR PACKAGINGS□

AND PACKAGES. . . . .	89
Requirements for radioactive material (601–605) . . . . .	89
Requirements for material excepted from fissile classification (606). . . . .	90
General requirements for all packagings and packages (607–618). . . . .	90
Additional requirements for packages transported by air (619–621) . . . . .	92
Requirements for excepted packages (622) . . . . .	92
Requirements for industrial packages (623–630) . . . . .	92
Requirements for packages containing uranium hexafluoride (631–634) . . .	95
Requirements for Type A packages (635–651). . . . .	96
Requirements for Type B(U) packages (652–666) . . . . .	98
Requirements for Type B(M) packages (667–668). . . . .	100
Requirements for Type C packages (669–672). . . . .	101
Requirements for packages containing fissile material (673–686) . . . . .	102

SECTION VII. TEST PROCEDURES . . . . . 109

Demonstration of compliance (701–702) . . . . .	109
Leaching test for <del>LSA-III material and</del> low dispersible□ radioactive material (703) . . . . .	109
Tests for special form radioactive material (704–711) . . . . .	110
Tests for low dispersible radioactive material (712). . . . .	112
Tests for packages (713–737) . . . . .	112

SECTION VIII. APPROVAL AND ADMINISTRATIVE□  
REQUIREMENTS. . . . . 119

General (801–802). . . . .	119
Approval of special form radioactive material and□ low dispersible radioactive material (803–804). . . . .	120
Approval of material excepted from fissile classification (805–806) . . . . .	120

Approval of package designs (807–816) . . . . .	121
Approval of alternative activity limits for an exempt consignment□ of instruments or articles (817–818) . . . . .	123
Transitional arrangements (819–823) . . . . .	124
Notification and registration of serial numbers (824) . . . . .	126
Approval of shipments (825–828) . . . . .	126
Approval of shipments under special arrangement (829–831) . . . . .	127
Competent authority certificates of approval (832–833) . . . . .	128
Contents of certificates of approval (834–839) . . . . .	131
Validation of certificates (840) . . . . .	137

REFERENCES . . . . .	139
----------------------	-----

ANNEX I: SUMMARY OF APPROVAL AND□ PRIOR NOTIFICATION REQUIREMENTS . . . . .	141
ANNEX II: CONVERSION FACTORS AND PREFIXES . . . . .	147
ANNEX III: SUMMARY OF CONSIGNMENTS REQUIRING□ EXCLUSIVE USE . . . . .	149
CONTRIBUTORS TO DRAFTING AND REVIEW (2012) . . . . .	151
BODIES FOR THE ENDORSEMENT OF□ IAEA SAFETY STANDARDS . . . . .	159
INDEX . . . . .	163

LIST OF TABLES

Table 1. Excerpts from the list of UN numbers, proper shipping names and descriptions . . . . .	22
Table 2. Basic radionuclide values . . . . .	25
Table 3. Basic radionuclide values for unknown radionuclides or mixtures . . . . .	46
Table 4. Activity limits for excepted packages. . . . .	51
Table 5. Industrial package requirements for LSA material and SCO . . . . .	62
Table 6. Conveyance activity limits for LSA material and SCO in industrial packages or unpacked . . . . .	63
Table 7. Multiplication factors for tanks, freight containers and unpackaged LSA-I and SCO-I . . . . .	64
Table 8. Categories of packages, overpacks and freight containers . . . . .	65
Table 9. UN marking for packages and overpacks. . . . .	66
Table 10. Transport index limits for freight containers and conveyances not under exclusive use . . . . .	81
Table 11. CSI limits for freight containers and conveyances containing fissile material . . . . . .	82
Table 12. Insulation data. . . . .	99
Table 13. Values of Z for calculation of CSI in accordance with para. 674 . . . . .	103
Table 14. Free drop distance for testing packages to normal conditions of transport . . . . . . . . .	114

## Section I

### INTRODUCTION

#### BACKGROUND

101. These Regulations establish standards of safety which provide an acceptable level of control of the radiation, criticality and thermal hazards to persons, property and the environment that are associated with the transport of radioactive material. These Regulations are based on the Fundamental Safety Principles, Safety Fundamentals No. SF-1 [1], jointly sponsored by the European Atomic Energy Community (EAEC), the Food and Agriculture Organization of the United Nations (FAO), the IAEA, the International Labour Organization (ILO), the International Maritime Organization (IMO), the OECD Nuclear Energy Agency (NEA), the Pan American Health Organization (PAHO), the United Nations Environment Programme (UNEP) and the World Health Organization (WHO), ~~and on the Radiation Protection and Safety of Radiation Sources: International Basic Safety Standards Series No. GSR Part 3.. the International Basic Safety Standards for Protection against Ionizing Radiation and for the Safety of Radiation Sources, Safety Series No. 115~~ [2], jointly sponsored by ~~EC, FAO, IAEA, ILO, OECD/NEA, PAHO, UNEP and WHO~~ the FAO, the IAEA, the ILO, the NEA, the PAHO and the WHO, on the Governmental, Legal and Regulatory Framework for Safety, Series No. GSR Part 1 (Rev. 1), [18] and the Leadership and Management for Safety, Draft General Safety Requirements, Series No. GSR Part 2 [19]. Thus, compliance with these Regulations is deemed to satisfy the principles of the Basic Safety Standards in respect of transport. In accordance with Ref. [1], the prime responsibility for safety must rest with the person or organization responsible for facilities and activities that give rise to radiation risks.

102. This Safety Standard is supplemented by a hierarchy of Safety Guides, including: Advisory Material for the IAEA Regulations for the Safe Transport of Radioactive Material, IAEA ~~Safety Standards~~ Series No. ~~TS-G-1.1 (Rev. 1)~~ SSG-26 (20xx Edition to coincide with this Edition of the Regulations under development) [3]; Planning and Preparing for Emergency Response to Transport Accidents Involving Radioactive Material, IAEA Safety Standards Series No. TS-G-1.2 (ST-3) [4]; Compliance Assurance for the Safe Transport of Radioactive Material, IAEA Safety Standards Series No. TS-G-1.5 [5]; The Management System for the Safe Transport of Radioactive Material, IAEA Safety Standards Series No. TS-G-1.4 [6]; ~~and~~, Radiation Protection Programmes for the Transport of Radioactive Material, IAEA Safety Standards Series No. TS-G-1.3 [7] and Schedules of Provisions of the IAEA Regulations for the Safe Transport of Radioactive Material (2012 Edition), Series No. SSG-33 [17]. (20xx Edition to coincide with this Edition of the Regulations under development)

103. In certain parts of these Regulations, a particular action is prescribed, but the responsibility for carrying out the action is not specifically assigned to any particular person. Such responsibility may vary according to the laws and customs of different countries and the international conventions into which these make this assignment, but only to identify the action itself. It remains the prerogative of each government to assign this responsibility.

103 bis. The principal topic that justified a new edition of the IAEA Transport Regulations is the new category of Surface Contaminated Objects (SCO-III). Special consideration is given to the transport after long storage, clarification and harmonization of the regulations.

#### OBJECTIVE

104. The objective of these Regulations is to establish requirements that must be satisfied to ensure safety and to protect persons, property and the environment from the effects of radiation in the transport of radioactive material. This protection is achieved by requiring:

- (a) Containment of the radioactive contents;
- (b) Control of external ~~radiation level~~ dose equivalent rate;
- (c) Prevention of criticality;
- (d) Prevention of damage caused by heat.

These requirements are satisfied firstly by applying a graded approach to contents limits for packages and conveyances and to performance standards applied to package designs, depending upon the hazard of the radioactive contents.

Secondly, they are satisfied by imposing conditions on the design and operation of packages and on the maintenance of packagings, including consideration of the nature of the radioactive contents. Thirdly, they are satisfied by requiring administrative controls, including, where appropriate, approval by competent authorities Finally, they are satisfied by making arrangements for planning and preparing emergency response in order to mitigate the consequences of potential events.

105. In the transport of radioactive material, the safety of persons and the protection of property and the environment are assured when these Regulations are complied with. Confidence in this regard is achieved through management system and compliance assurance programmes.

#### SCOPE

106. These Regulations apply to the transport of radioactive material by all modes on land, water, or in the air, including transport that is incidental to the use of the

radioactive material. Transport comprises all operations and conditions associated with, and involved in, the movement of radioactive material; these include the design, manufacture, maintenance and repair of packaging, and the preparation, consigning, loading, carriage including in-transit storage, shipment after storage, unloading and receipt at the final destination of loads of radioactive material and packages. A graded approach is applied in specifying the performance standards in these Regulations, which are characterized in terms of three general severity levels:

- (a) Routine conditions of transport (incident free);
- (b) Normal conditions of transport (minor mishaps);
- (c) Accident conditions of transport.

107. These Regulations do not apply to any of the following:

- (a) Radioactive material that is an integral part of the means of transport.
- (b) Radioactive material moved within an establishment that is subject to appropriate safety regulations in force in the establishment and where the movement does not involve public roads or railways.
- (c) Radioactive material implanted or incorporated into a person or live animal for diagnosis or treatment.
- (d) Radioactive material in or on a person who is to be transported for medical treatment because the person has been subject to accidental or deliberate intake of radioactive material or to contamination.
- (e) Radioactive material in consumer products that have received regulatory approval, following their sale to the end user.
- (f) Natural material and ores containing naturally occurring radionuclides, which may have been processed, provided the activity concentration of the material does not exceed 10 times the values specified in Table 2, or calculated in accordance with paras 403(a) and 404–407. For natural materials and ores containing naturally occurring radionuclides that are not in secular equilibrium the calculation of the activity concentration shall be performed in accordance with para. 405.
- (g) Non-radioactive solid objects with radioactive substances present on any surface in quantities not in excess of the levels defined in para. 214.

108. These Regulations do not specify controls such as routing or physical protection that may be instituted for reasons other than radiological safety. Any such controls shall take into account radiological and non-radiological hazards, and shall not detract from the standards of safety that these Regulations are intended to provide.

109. Measures should be taken to ensure that radioactive material is kept secure in transport so as to prevent theft or damage and to ensure that control of the material is not relinquished inappropriately (see Annex I).

110. For radioactive material having subsidiary risks, and for transport of radioactive material with other dangerous goods, the relevant transport regulations for dangerous goods shall apply in addition to these Regulations.

## STRUCTURE

111. This publication is structured so that Section II defines the terms that are required for the purposes of these Regulations; Section III provides general provisions; Section IV provides activity limits and material restrictions used throughout these Regulations; Section V provides requirements and controls for transport; Section VI provides requirements for radioactive material and for packagings and packages; Section VII provides requirements for test procedures; and Section VIII provides requirements for approvals and administration.

## Section II

### DEFINITIONS

The following definitions shall apply for the purposes of these Regulations:

$A_1$  and  $A_2$

201.  $A_1$  shall mean the activity value of *Special form radioactive material* that is listed in Table 2 or derived in Section IV and is used to determine the activity limits for the requirements of these Regulations.  $A_2$  shall mean the activity value of *radioactive material*, other than *Special form radioactive material*, that is listed in Table 2 or derived in Section IV and is used to determine the activity limits for the requirements of these Regulations.

*Aircraft*

202. Cargo *aircraft* shall mean any *aircraft*, other than a passenger *aircraft*, that is carrying goods or property.

203. Passenger *aircraft* shall mean an *aircraft* that carries any person other than a crew member, a *carrier's* employee in an official capacity, an authorized representative of an appropriate national authority, or a person accompanying a *consignment* or other cargo.

*Approval*

204. *Multilateral approval* shall mean *approval* by the relevant *competent authority* of the country of origin of the *design* or *Shipment*, as applicable, and also, where the *consignment* is to be transported *Through or into* any other country, *approval* by the *competent authority* of that country.

205. *Unilateral approval* shall mean an *approval* of a *design* that is required to be given by the *competent authority* of the country of origin of the *design* only.

*Carrier*

206. *Carrier* shall mean any person, organization or government undertaking the carriage of *radioactive material* by any means of transport. The term includes both *carriers* for hire or reward (known as common or contract *carriers* in some countries) and *carriers* on own account (known as private *carriers* in some countries).

*Competent authority*

207. *Competent authority* shall mean any body or authority *designated* or otherwise recognized as such for any purpose in connection with these Regulations.

#### *Compliance assurance*

208. *Compliance assurance* shall mean a systematic programme of measures applied by a *competent authority* that is aimed at ensuring that the provisions of these Regulations are met in practice.

#### *Confinement system*

209. *Confinement system* shall mean the assembly of *Fissile material* and *packaging* components specified by the *designer* and agreed to by the *competent authority* as intended to preserve criticality safety.

#### *Consignee*

210. *Consignee* shall mean any person, organization or government that is entitled to take delivery of a *consignment*.

#### *Consignment*

211. *Consignment* shall mean any *package* or *packages*, or load of *radioactive material*, presented by a *consignor* for transport.

#### *Consignor*

212. *Consignor* shall mean any person, organization or government that prepares a *consignment* for transport.

#### *Containment system*

213. *Containment system* shall mean the assembly of components of the *packaging* specified by the *designer* as intended to retain the *radioactive material* during transport.

#### *Contamination*

214. *Contamination* shall mean the presence of a radioactive substance on a surface in quantities in excess of 0.4 Bq/cm<sup>2</sup> for beta and gamma emitters and *low toxicity alpha emitters*, or 0.04 Bq/cm<sup>2</sup> for all other alpha emitters.

215. *Non-fixed contamination* shall mean *contamination* that can be removed from a surface during routine conditions of transport.

216. *Fixed contamination* shall mean *contamination* other than *non-fixed contamination*.

#### *Conveyance*

217. *Conveyance* shall mean:

(a) For transport by road or rail: any *vehicle*.

(b) For transport by water: any *vessel*, or any hold, compartment, or *defined deck area* of a *vessel*.

(c) For transport by air: any *aircraft*.

#### *Criticality safety index*

218. *Criticality safety index (CSI)* assigned to a *package*, *Overpack* or *freight container* containing *Fissile material* shall mean a number that is used to provide control over the accumulation of *packages*, *Overpacks* or *freight containers* containing *fissile material*.

#### *Defined deck area*

219. *Defined deck area* shall mean the area of the weather deck of a *vessel*, or of a *vehicle* deck of a roll-on/roll-off ship or ferry, that is allocated for the stowage of *radioactive material*.

#### *Design*

220. *Design* shall mean the description of *Fissile material* excepted under para. 417(f), *Special form radioactive material*, *low dispersible radioactive material*, *package* or *packaging* that enables such an item to be fully identified.

The description may include specifications, engineering drawings, reports demonstrating compliance with regulatory requirements, and other relevant documentation.

#### *Dose Equivalent Rate*

220 bis. *Dose equivalent rate* shall mean the ambient dose equivalent or the directional dose equivalent, as appropriate, per unit time, measured at the point of interest and expressed in millisieverts per hour or microsieverts per hour.

#### *Exclusive use*

221. *Exclusive use* shall mean the sole use, by a single *consignor*, of a *conveyance* or of a *large freight container*, in respect of which all initial,

intermediate and final loading and unloading and *Shipment* are carried out in accordance with the directions of the *consignor* or *consignee*, where so required by these Regulations.

*fissile nuclides and fissile material*

222. *Fissile nuclides* shall mean uranium-233, uranium-235, plutonium-239 and plutonium-241. *Fissile material* shall mean a material containing any of the *fissile nuclides*. Excluded from the definition of *fissile material* are the following:

- (a) *Natural uranium* or *depleted uranium* that is unirradiated;
- (b) *Natural uranium* or *depleted uranium* that has been irradiated in thermal reactors only;
- (c) Material with *fissile nuclides* less than a total of 0.25 g;
- (d) Any combination of (a), (b) and/or (c).

These exclusions are only valid if there is no other material with *Fissile nuclides* in the *package* or in the *consignment* if shipped unpackaged.

*Freight container — small, large*

223. *Freight container* shall mean an article of transport equipment that is of a permanent character and accordingly strong enough to be suitable for repeated use; specially designed to facilitate the transport of goods, by one or other modes of transport, without intermediate reloading, designed to be secured and/or readily handled, having fittings for these purposes. The term “*freight container*” does not include the *vehicle*.

A *small freight container* shall mean a *freight container* that has an internal volume of not more than 3 m<sup>3</sup>. A *large freight container* shall mean a *freight container* that has an internal volume of more than 3 m<sup>3</sup>.

*Intermediate bulk container*

224. *Intermediate bulk container (IBC)* shall mean a portable *packaging* that:

- (a) Has a capacity of not more than 3 m<sup>3</sup>;
- (b) Is designed for mechanical handling;
- (c) Is resistant to the stresses produced in handling and transport, as determined by tests.

*Low dispersible radioactive material*

225. *Low dispersible radioactive material* shall mean either a solid *radioactive material* or a solid *radioactive material* in a sealed capsule, that has limited dispersibility and is not in powder form.

#### *Low Specific activity material*

226. *Low specific activity (LSA) material* shall mean *radioactive material* that by its nature has a limited *specific activity*, or *radioactive material* for which limits of estimated average *specific activity* apply. External shielding materials surrounding the *LSA material* shall not be considered in determining the estimated average *specific activity*.

#### *Low toxicity alpha emitters*

227. *Low toxicity alpha emitters* are: *natural uranium, depleted uranium, natural thorium, uranium-235, uranium-238, thorium-232, thorium-228 and thorium-230* when contained in ores or physical and chemical concentrates; or alpha emitters with a half-life of less than 10 days.

#### *Management system*

228. *Management system* shall mean a set of interrelated or interacting elements (system) for establishing policies and objectives and enabling the objectives to be achieved in an efficient and effective manner.

#### *Maximum normal operating pressure*

229. *Maximum normal operating pressure* shall mean the maximum pressure above atmospheric pressure at mean sea level that would develop in the *containment system* in a period of one year under the conditions of temperature and solar radiation corresponding to environmental conditions in the absence of venting, external cooling by an ancillary system, or operational controls during transport.

#### *Overpack*

230. *Overpack* shall mean an enclosure used by a single *consignor* to contain one or more *packages* and to form one unit for convenience of handling and stowage during transport.

#### *Package*

231. *Package* shall mean the complete product of the packing operation, consisting of the *packaging* and its contents prepared for transport. The types of

*package* covered by these Regulations that are subject to the activity limits and material restrictions of Section IV and meet the corresponding requirements are:

- (a) *Excepted package*;
- (b) *Industrial package Type 1 (Type IP-1)*;
- (c) *Industrial package Type 2 (Type IP-2)*;
- (d) *Industrial package Type 3 (Type IP-3)*;
- (e) *Type A package*;
- (f) *Type B(U) package*;
- (g) *Type B(M) package*;
- (h) *Type C package*.

*Packages* containing *Fissile material* or uranium hexafluoride are subject to additional requirements.

#### *Packaging*

232. *Packaging* shall mean one or more receptacles and any other components or materials necessary for the receptacles to perform the containment and other safety functions.

#### ~~Radiation level~~ *Dose Equivalent Rate [to be moved to 220bis]*

233. ~~Radiation level~~ *Dose equivalent rate* shall mean ~~the corresponding dose rate expressed in millisieverts per hour or microsieverts per hour the ambient dose equivalent or the directional dose equivalent, as appropriate, per unit time, measured at the point of interest and expressed in millisieverts per hour or microsieverts per hour.~~

#### *Radiation protection programme*

234. *Radiation protection programme* shall mean systematic arrangements that are aimed at providing adequate consideration of radiation protection measures.

#### *Radioactive contents*

235. *Radioactive contents* shall mean the *radioactive material* together with any contaminated or activated solids, liquids and gases within the *packaging*.

#### *Radioactive material*

236. *Radioactive material* shall mean any material containing radionuclides where both the activity concentration and the total activity in the *consignment* exceed the values specified in paras 402–407.

#### *Shipment*

237. *Shipment* shall mean the specific movement of a *consignment* from origin to destination.

#### *Special arrangement*

238. *Special arrangement* shall mean those provisions, approved by the *competent authority*, under which *consignments* that do not satisfy all the applicable requirements of these Regulations may be transported.

#### *Special form radioactive material*

239. *Special form radioactive material* shall mean either an indispersible solid *radioactive material* or a sealed capsule containing *radioactive material*.

#### *Specific activity*

240. *Specific activity* of a radionuclide shall mean the activity per unit mass of that nuclide. The *specific activity* of a material shall mean the activity per unit mass of the material in which the radionuclides are essentially uniformly distributed.

#### *Surface contaminated object*

241. *Surface contaminated object (SCO)* shall mean a solid object that is not itself radioactive but which has *radioactive material* distributed on its surface.

#### *Tank*

242. *Tank* shall mean a portable *Tank* (including a *Tank* container), a road *Tank vehicle*, a rail *Tank* wagon or a receptacle that contains solids, liquids, or gases, having a capacity of not less than 450 L when used for the transport of gases.

#### *Through or into*

243. *Through or into* shall mean *through or into* the countries in which a *consignment* is transported but specifically excludes countries over which a *consignment* is carried by air, provided that there are no scheduled stops in those countries.

#### *Transport index*

244. *Transport index (TI)* assigned to a *package*, *overpack* or *freight container*, or to unpackaged *LSA-I*, ~~or SCO-I~~ or *SCO-III*, shall mean a number that is used to provide control over radiation exposure.

#### *Unirradiated thorium*

245. *Unirradiated thorium* shall mean thorium containing not more than  $10^{-7}$  g of uranium-233 per gram of thorium-232.

*Unirradiated uranium*

246. *Unirradiated uranium* shall mean *uranium* containing not more than  $2 \times 10^3$  Bq of plutonium per gram of uranium-235, not more than  $9 \times 10^6$  Bq of fission products per gram of uranium-235 and not more than  $5 \times 10^{-3}$  g of uranium-236 per gram of uranium-235.

*Uranium — natural, depleted, enriched*

247. *Natural uranium* shall mean *uranium* (which may be chemically separated) containing the naturally occurring distribution of *uranium* isotopes (approximately 99.28% uranium-238 and 0.72% uranium-235, by mass).

*Depleted uranium* shall mean *uranium* containing a lesser mass percentage of uranium-235 than *natural uranium*. *Enriched uranium* shall mean *uranium* containing a greater mass percentage of uranium-235 than 0.72%. In all cases, a very small mass percentage of uranium-234 is present.

*Vehicle*

248. *Vehicle* shall mean a road *vehicle* (including an articulated *vehicle*, i.e. a tractor and semi-trailer combination), railroad car or railway wagon. Each trailer shall be considered as a separate *vehicle*.

*Vessel*

249. *Vessel* shall mean any seagoing *vessel* or inland waterway craft used for carrying cargo.

### Section III GENERAL PROVISIONS

#### RADIATION PROTECTION

301. Doses to persons shall be below the relevant dose limits in accordance with GSR Part 3 [2]. Protection and safety shall be optimized in order that the magnitude of individual doses, the number of persons exposed and the likelihood of incurring exposure shall be kept as low as reasonably achievable, economic and social factors being taken into account, within the restriction that the doses to individuals are subject to dose constraints. A structured and systematic approach shall be adopted and shall include consideration of the interfaces between transport and other activities.

302. A *Radiation protection programme* shall be established for the transport of *radioactive material*. The nature and extent of the measures to be employed in the programme shall be related to the magnitude and likelihood of radiation exposures. The programme shall incorporate the requirements of paras 301, 303–305, 311 and 562. Programme documents shall be available, on request, for inspection by the relevant *competent authority*.

303. For occupational exposures arising from transport activities, where it is assessed that the effective dose either:

- (a) Is likely to be between 1 and 6 mSv in a year, a dose assessment programme via workplace monitoring or individual monitoring shall be conducted; or
- (b) Is likely to exceed 6 mSv in a year, individual monitoring shall be conducted.

When individual monitoring or workplace monitoring is conducted, appropriate records shall be kept.

#### EMERGENCY RESPONSE

304. In the event of nuclear or radiological emergency during the transport of *radioactive material*, provisions established by relevant national and/or international organizations shall be observed to protect human life, health, property and the environment. ~~emergency provisions, as established by relevant national and/or international organizations, shall be observed to protect persons, property and the environment.~~ Consignors and carriers shall establish, in advance, arrangements for preparedness and response for emergencies that may occur during transport in order to provide information and support to response organizations ~~accordance with [14] that are coordinated with respective off-site response organizations.~~ Appropriate guidelines for

~~the establishment of such provisions are contained in~~ Further guidance on emergency preparedness and response are found in ~~Ref~~ [4, 15, 16].

305. Emergency ~~procedures-arrangements~~ shall take into account all postulated events, including those of very low probability, and shall consider the formation of other dangerous substances that may result from the reaction between the contents of a *consignment* and the environment in the event of an accident.

## MANAGEMENT SYSTEM

306. A *management system* based on international, national or other standards acceptable to the *competent authority* shall be established and implemented for all activities within the scope of the Regulations, as identified in para. 106, to ensure compliance with the relevant provisions of these Regulations. Certification that the *design* specification has been fully implemented shall be available to the *competent authority*. The manufacturer, *consignor* or user shall be prepared:

- (a) To provide facilities for inspection during manufacture and use;
- (b) To demonstrate compliance with these Regulations to the *competent authority*.

Where *competent authority approval* is required, such *approval* shall take into account and be contingent upon the adequacy of the *management system*.

## COMPLIANCE ASSURANCE

307. The *competent authority* shall assure compliance with these Regulations.

308. The relevant *competent authority* shall arrange for periodic assessments of the radiation doses to persons due to the transport of *radioactive material*, to ensure that the system of protection and safety complies with the Basic Safety Standards [2].

## NON-COMPLIANCE

309. In the event of non-compliance with any limit in these Regulations applicable to ~~radiation level~~ dose equivalent rate or contamination:

(a) The *consignor*, *consignee*, *carrier* and any organization involved during transport who may be affected, as appropriate, shall be informed of the non-compliance by:

- (i) The *carrier* if the non-compliance is identified during transport; or

- (ii) The *consignee* if the non-compliance is identified at receipt.
- (b) The *carrier, consignor* or *consignee*, as appropriate, shall:
- (i) Take immediate steps to mitigate the consequences of the noncompliance;
  - (ii) Investigate the non-compliance and its causes, circumstances and consequences;
  - (iii) Take appropriate action to remedy the causes and circumstances that led to the non-compliance and to prevent a recurrence of circumstances similar to those that led to the non-compliance;
  - (iv) Communicate to the relevant *competent authority(ies)* on the causes of the non-compliance and on corrective or preventive actions taken or to be taken.
- (c) The communication of the non-compliance to the *consignor* and the relevant *competent authority(ies)*, respectively, shall be made as soon as practicable and it shall be immediate whenever an emergency exposure situation has developed or is developing.

#### SPECIAL ARRANGEMENT

310. *Consignments* for which conformity with the other provisions of these Regulations is impracticable shall not be transported except under *special arrangement*. Provided the *competent authority* is satisfied that conformity with the other provisions of these Regulations is impracticable and that the requisite standards of safety established by these Regulations have been demonstrated through means alternative to the other provisions, the *competent authority* may approve *special arrangement* transport operations for single or a planned series of multiple *consignments*. The overall level of safety in transport shall be at least equivalent to that which would be provided if all the applicable requirements had been met. For *consignments* of this type, *multilateral approval* shall be required.

#### TRAINING

311. Workers shall receive appropriate training concerning radiation protection, including the precautions to be observed in order to restrict their occupational exposure and the exposure of other persons who might be affected by their actions.

312. Persons engaged in the transport of *radioactive material* shall receive training in the contents of these Regulations commensurate with their responsibilities.

313. Individuals such as those who classify *radioactive material*; pack *radioactive material*; mark and label *radioactive material*; prepare transport documents for *radioactive material*; offer or accept *radioactive material* for transport; carry or handle *radioactive material* in transport; mark or placard or load or unload *packages* of *radioactive material* into or from transport *vehicles*, bulk *packagings* or *freight containers*; or are otherwise directly involved in the transport of *radioactive material* as determined by the *competent authority*; shall receive the following training:

(a) General awareness/familiarization training:

(i) Each person shall receive training designed to provide familiarity with the general provisions of these Regulations.

(ii) Such training shall include a description of the categories of *radioactive material*; labelling, marking, placarding and *packaging* and segregation requirements; a description of the purpose and content of the *radioactive material* transport document; and a description of available emergency response documents.

(b) Function specific training: Each person shall receive detailed training concerning specific *radioactive material* transport requirements that are applicable to the function that person performs;

(c) Safety training: Commensurate with the risk of exposure in the event of a release and the functions performed, each person shall receive training on:

(i) Methods and procedures for accident avoidance, such as proper use of *package* handling equipment and appropriate methods of stowage of *radioactive material*.

(ii) Available ~~emergency response~~ information for any relevant abnormal event during transport and how to use it.

(iii) General dangers presented by the various categories of *radioactive material* and how to prevent exposure to those hazards, including, if appropriate, the use of personal protective clothing and equipment.

(iv) Immediate procedures to be followed in the event of an unintentional release of *radioactive material*, including any emergency response

procedures for which the person is responsible and personal protection procedures to be followed.

314. Records of all safety training undertaken shall be kept by the employer and made available to the employee if requested.

315. The training required in para. 313 shall be provided or verified upon employment in a position involving *radioactive material* transport and shall be periodically supplemented with retraining as deemed appropriate by the *competent authority*.

## Section IV

### ACTIVITY LIMITS AND CLASSIFICATION

#### GENERAL PROVISIONS

401. *Radioactive material* shall be assigned to one of the UN numbers specified in Table 1 in accordance with paras 408–434.

#### BASIC RADIONUCLIDE VALUES

402. The following basic values for individual radionuclides are given in Table 2:

- (a)  $A_1$  and  $A_2$  in TBq;
- (b) Activity concentration limits for exempt material in Bq/g;
- (c) Activity limits for exempt *consignments* in Bq.

#### DETERMINATION OF BASIC RADIONUCLIDE VALUES

403. For individual radionuclides:

- (a) That are not listed in Table 2, the determination of the basic radionuclide values referred to in para. 402 shall require *multilateral approval*. For these radionuclides, activity concentrations for exempt material and activity limits for exempt *consignments* shall be calculated in accordance with the principles established in the BSS [2]. It is permissible to use an  $A_2$  value calculated using a dose coefficient for the appropriate lung absorption type, as recommended by the International Commission on Radiological Protection, if the chemical forms of each radionuclide under both normal and accident conditions of transport are taken into consideration. Alternatively, the radionuclide values in Table 3 may be used without obtaining *competent authority approval*.
- (b) In instruments or articles in which the *radioactive material* is enclosed in or is included as a component part of the instrument or other manufactured article and which meets para. 423(c), alternative basic radionuclide values to those in Table 2 for the activity limit for an exempt *consignment* are permitted and shall require *multilateral approval*. Such alternative activity limits for an exempt *consignment* shall be calculated in accordance with the principles set out in the BSS [2].

TABLE 1. EXCERPTS FROM THE LIST OF UN NUMBERS, PROPER SHIPPING NAMES AND DESCRIPTIONS

Assignment of UN numbers	PROPER SHIPPING NAME and description <sup>a</sup>
<i>Excepted package</i>	
UN 2908	RADIOACTIVE MATERIAL, EXCEPTED PACKAGE — EMPTY PACKAGING
UN 2909	RADIOACTIVE MATERIAL, EXCEPTED PACKAGE — ARTICLES MANUFACTURED FROM NATURAL URANIUM or DEPLETED URANIUM or NATURAL THORIUM
UN 2910	RADIOACTIVE MATERIAL, EXCEPTED PACKAGE — LIMITED QUANTITY OF MATERIAL
UN 2911	RADIOACTIVE MATERIAL, EXCEPTED PACKAGE — INSTRUMENTS or ARTICLES
UN 3507	URANIUM HEXAFLUORIDE, RADIOACTIVE MATERIAL, EXCEPTED PACKAGE, less than 0.1 kg per package, non-fissile or fissile-excepted <sup>b</sup>
<i>Low Specific activity material</i>	
UN 2912	RADIOACTIVE MATERIAL, LOW SPECIFIC ACTIVITY (LSA-I), non-fissile or fissile-excepted <sup>b</sup>
UN 3321	RADIOACTIVE MATERIAL, LOW SPECIFIC ACTIVITY (LSA-II), non-fissile or fissile-excepted <sup>b</sup>
UN 3322	RADIOACTIVE MATERIAL, LOW SPECIFIC ACTIVITY (LSA-III), non-fissile or fissile-excepted <sup>b</sup>
UN 3324	RADIOACTIVE MATERIAL, LOW SPECIFIC ACTIVITY (LSA-II), FISSILE
UN 3325	RADIOACTIVE MATERIAL, LOW SPECIFIC ACTIVITY (LSA-III), FISSILE
<i>Surface contaminated objects</i>	
UN 2913	RADIOACTIVE MATERIAL, SURFACE CONTAMINATED OBJECTS (SCO-I, <del>or</del> SCO-II <u>or SCO-III</u> ), non-fissile or fissile-excepted <sup>b</sup>
UN 3326	RADIOACTIVE MATERIAL, SURFACE CONTAMINATED OBJECTS (SCO-I or SCO-II), FISSILE

TABLE 1. EXCERPTS FROM THE LIST OF UN NUMBERS, PROPER SHIPPING NAMES AND DESCRIPTIONS (cont.)

Assignment of UN numbers	PROPER SHIPPING NAME and description <sup>a</sup>
<i>Type A package</i>	
UN 2915	RADIOACTIVE MATERIAL, TYPE A PACKAGE, non-special form, non-fissile or fissile-excepted <sup>b</sup>
UN 3327	RADIOACTIVE MATERIAL, TYPE A PACKAGE, FISSILE, non-special form
UN 3332	RADIOACTIVE MATERIAL, TYPE A PACKAGE, SPECIAL FORM, non-fissile or fissile-excepted <sup>b</sup>
UN 3333	RADIOACTIVE MATERIAL, TYPE A PACKAGE, SPECIAL FORM, FISSILE
<i>Type B(U) package</i>	
UN 2916	RADIOACTIVE MATERIAL, TYPE B(U) PACKAGE, non-fissile or fissile-excepted <sup>b</sup>
UN 3328	RADIOACTIVE MATERIAL, TYPE B(U) PACKAGE, FISSILE
<i>Type B(M) package</i>	
UN 2917	RADIOACTIVE MATERIAL, TYPE B(M) PACKAGE, non-fissile or fissile-excepted <sup>b</sup>
UN 3329	RADIOACTIVE MATERIAL, TYPE B(M) PACKAGE, FISSILE
<i>Type C package</i>	
UN 3323	RADIOACTIVE MATERIAL, TYPE C PACKAGE, non-fissile or fissile-excepted <sup>b</sup>
UN 3330	RADIOACTIVE MATERIAL, TYPE C PACKAGE, FISSILE
<i>Special arrangement</i>	
UN 2919	RADIOACTIVE MATERIAL, TRANSPORTED UNDER SPECIAL ARRANGEMENT, non-fissile or fissile-excepted <sup>b</sup>
UN 3331	RADIOACTIVE MATERIAL, TRANSPORTED UNDER SPECIAL ARRANGEMENT, FISSILE
Uranium hexafluoride	
UN 2977	RADIOACTIVE MATERIAL, URANIUM HEXAFLUORIDE, FISSILE
UN 2978	RADIOACTIVE MATERIAL, URANIUM HEXAFLUORIDE, non-fissile or fissile-excepted <sup>b</sup>

404. In the calculations of  $A_1$  and  $A_2$  for a radionuclide not listed in Table 2, a single radioactive decay chain in which the radionuclides are present in their naturally occurring proportions, and in which no daughter nuclide has a half-life either longer than 10 days or longer than that of the parent nuclide, shall be considered as a single radionuclide; and the activity to be taken into account and the  $A_1$  or  $A_2$  value to be applied shall be that corresponding to the parent nuclide of that chain. In the case of radioactive decay chains in which any daughter nuclide has a half-life either longer than 10 days or longer than that of the parent nuclide, the parent and such daughter nuclides shall be considered as mixtures of different nuclides.

405. For mixtures of radionuclides, the basic radionuclide values referred to in para. 402 may be determined as follows:

$$X_m = \frac{1}{\sum_i \frac{f(i)}{X(i)}}$$

where

$f(i)$  is the fraction of activity or activity concentration of radionuclide  $i$  in the mixture.

$X(i)$  is the appropriate value of  $A_1$  or  $A_2$ , or the activity concentration limit for exempt material or the activity limit for an exempt *consignment* as appropriate for the radionuclide  $i$ .

$X_m$  is the derived value of  $A_1$  or  $A_2$ , or the activity concentration limit for exempt material or the activity limit for an exempt *consignment* in the case of a mixture.

TABLE 2. BASIC RADIONUCLIDE VALUES

Radionuclide (atomic number)	<i>A1</i>	<i>A2</i>	Activity concentration limit for exempt material	Activity limit for an exempt <i>consignment</i>
	(TBq)	(TBq)	(Bq/g)	(Bq)
Actinium (89)				
Ac-225 (a)	$8 \times 10^{-1}$	$6 \times 10^{-3}$	$1 \times 10^1$	$1 \times 10^4$
Ac-227 (a)	$9 \times 10^{-1}$	$9 \times 10^{-5}$	$1 \times 10^{-1}$	$1 \times 10^3$
Ac-228	$6 \times 10^{-1}$	$5 \times 10^{-1}$	$1 \times 10^1$	$1 \times 10^6$
Silver (47)				
Ag-105	$2 \times 10^0$	$2 \times 10^0$	$1 \times 10^2$	$1 \times 10^6$
Ag-108m (a)	$7 \times 10^{-1}$	$7 \times 10^{-1}$	$1 \times 10^1$ (b)	$1 \times 10^6$ (b)
Ag-110m (a)	$4 \times 10^{-1}$	$4 \times 10^{-1}$	$1 \times 10^1$	$1 \times 10^6$
Ag-111	$2 \times 10^0$	$6 \times 10^{-1}$	$1 \times 10^3$	$1 \times 10^6$
Aluminium (13)				
Al-26	$1 \times 10^{-1}$	$1 \times 10^{-1}$	$1 \times 10^1$	$1 \times 10^5$
Americium (95)				
Am-241	$1 \times 10^1$	$1 \times 10^{-3}$	$1 \times 10^0$	$1 \times 10^4$
Am-242m (a)	$1 \times 10^1$	$1 \times 10^{-3}$	$1 \times 10^0$ (b)	$1 \times 10^4$ (b)
Am-243 (a)	$5 \times 10^0$	$1 \times 10^{-3}$	$1 \times 10^0$ (b)	$1 \times 10^3$ (b)
Argon (18)				
Ar-37	$4 \times 10^1$	$4 \times 10^1$	$1 \times 10^6$	$1 \times 10^8$
Ar-39	$4 \times 10^1$	$2 \times 10^1$	$1 \times 10^7$	$1 \times 10^4$
Ar-41	$3 \times 10^{-1}$	$3 \times 10^{-1}$	$1 \times 10^2$	$1 \times 10^9$
Arsenic (33)				
As-72	$3 \times 10^{-1}$	$3 \times 10^{-1}$	$1 \times 10^1$	$1 \times 10^5$
As-73	$4 \times 10^1$	$4 \times 10^1$	$1 \times 10^3$	$1 \times 10^7$
As-74	$1 \times 10^0$	$9 \times 10^{-1}$	$1 \times 10^1$	$1 \times 10^6$
As-76	$3 \times 10^{-1}$	$3 \times 10^{-1}$	$1 \times 10^2$	$1 \times 10^5$
As-77	$2 \times 10^1$	$7 \times 10^{-1}$	$1 \times 10^3$	$1 \times 10^6$
Astatine (85)				
At-211 (a)	$2 \times 10^1$	$5 \times 10^{-1}$	$1 \times 10^3$	$1 \times 10^7$

For footnotes see pp. 43–46

TABLE 2. BASIC RADIONUCLIDE VALUES (cont.)

Radionuclide (atomic number)	A1	A2	Activity concentration limit for exempt material	Activity limit for an exempt <i>consignment</i>
	(TBq)	(TBq)	(Bq/g)	(Bq)
Gold (79)				
Au-193	$7 \times 10^0$	$2 \times 10^0$	$1 \times 10^2$	$1 \times 10^7$
Au-194	$1 \times 10^0$	$1 \times 10^0$	$1 \times 10^1$	$1 \times 10^6$
Au-195	$1 \times 10^1$	$6 \times 10^0$	$1 \times 10^2$	$1 \times 10^7$
Au-198	$1 \times 10^0$	$6 \times 10^{-1}$	$1 \times 10^2$	$1 \times 10^6$
Au-199	$1 \times 10^1$	$6 \times 10^{-1}$	$1 \times 10^2$	$1 \times 10^6$
Barium (56)				
Ba-131 (a)	$2 \times 10^0$	$2 \times 10^0$	$1 \times 10^2$	$1 \times 10^6$
Ba-133	$3 \times 10^0$	$3 \times 10^0$	$1 \times 10^2$	$1 \times 10^6$
Ba-133m	$2 \times 10^1$	$6 \times 10^{-1}$	$1 \times 10^2$	$1 \times 10^6$
<b>Ba-135m</b>	<b><math>2 \times 10^1</math></b>	<b><math>6 \times 10^{-1}</math></b>	<b><math>1 \times 10^1</math></b>	<b><math>1 \times 10^6</math></b>
Ba-140 (a)	$5 \times 10^{-1}$	$3 \times 10^{-1}$	$1 \times 10^1$ (b)	$1 \times 10^5$ (b)
Beryllium (4)				
Be-7	$2 \times 10^1$	$2 \times 10^1$	$1 \times 10^3$	$1 \times 10^7$
Be-10	$4 \times 10^1$	$6 \times 10^{-1}$	$1 \times 10^4$	$1 \times 10^6$
Bismuth (83)				
Bi-205	$7 \times 10^{-1}$	$7 \times 10^{-1}$	$1 \times 10^1$	$1 \times 10^6$
Bi-206	$3 \times 10^{-1}$	$3 \times 10^{-1}$	$1 \times 10^1$	$1 \times 10^5$
Bi-207	$7 \times 10^{-1}$	$7 \times 10^{-1}$	$1 \times 10^1$	$1 \times 10^6$
Bi-210	$1 \times 10^0$	$6 \times 10^{-1}$	$1 \times 10^3$	$1 \times 10^6$
Bi-210m (a)	$6 \times 10^{-1}$	$2 \times 10^{-2}$	$1 \times 10^1$	$1 \times 10^5$
Bi-212 (a)	$7 \times 10^{-1}$	$6 \times 10^{-1}$	$1 \times 10^1$ (b)	$1 \times 10^5$ (b)
Berkelium (97)				
Bk-247	$8 \times 10^0$	$8 \times 10^{-4}$	$1 \times 10^0$	$1 \times 10^4$
Bk-249 (a)	$4 \times 10^1$	$3 \times 10^{-1}$	$1 \times 10^3$	$1 \times 10^6$
Bromine (35)				
Br-76	$4 \times 10^{-1}$	$4 \times 10^{-1}$	$1 \times 10^1$	$1 \times 10^5$
Br-77	$3 \times 10^0$	$3 \times 10^0$	$1 \times 10^2$	$1 \times 10^6$
Br-82	$4 \times 10^{-1}$	$4 \times 10^{-1}$	$1 \times 10^1$	$1 \times 10^6$

TABLE 2. BASIC RADIONUCLIDE VALUES (cont.)

Radionuclide (atomic number)	A1	A2	Activity concentration limit for exempt material	Activity limit for an exempt <i>consignment</i>
	(TBq)	(TBq)	(Bq/g)	(Bq)
Carbon (6)				
C-11	$1 \times 10^0$	$6 \times 10^{-1}$	$1 \times 10^1$	$1 \times 10^6$
C-14	$4 \times 10^1$	$3 \times 10^0$	$1 \times 10^4$	$1 \times 10^7$
Calcium (20)				
Ca-41	Unlimited	Unlimited	$1 \times 10^5$	$1 \times 10^7$
Ca-45	$4 \times 10^1$	$1 \times 10^0$	$1 \times 10^4$	$1 \times 10^7$
Ca-47 (a)	$3 \times 10^0$	$3 \times 10^{-1}$	$1 \times 10^1$	$1 \times 10^6$
Cadmium (48)				
Cd-109	$3 \times 10^1$	$2 \times 10^0$	$1 \times 10^4$	$1 \times 10^6$
Cd-113m	$4 \times 10^1$	$5 \times 10^{-1}$	$1 \times 10^3$	$1 \times 10^6$
Cd-115 (a)	$3 \times 10^0$	$4 \times 10^{-1}$	$1 \times 10^2$	$1 \times 10^6$
Cd-115m	$5 \times 10^{-1}$	$5 \times 10^{-1}$	$1 \times 10^3$	$1 \times 10^6$
Cerium (58)				
Ce-139	$7 \times 10^0$	$2 \times 10^0$	$1 \times 10^2$	$1 \times 10^6$
Ce-141	$2 \times 10^1$	$6 \times 10^{-1}$	$1 \times 10^2$	$1 \times 10^7$
Ce-143	$9 \times 10^{-1}$	$6 \times 10^{-1}$	$1 \times 10^2$	$1 \times 10^6$
Ce-144 (a)	$2 \times 10^{-1}$	$2 \times 10^{-1}$	$1 \times 10^2$ (b)	$1 \times 10^5$ (b)
Californium (98)				
Cf-248	$4 \times 10^1$	$6 \times 10^{-3}$	$1 \times 10^1$	$1 \times 10^4$
Cf-249	$3 \times 10^0$	$8 \times 10^{-4}$	$1 \times 10^0$	$1 \times 10^3$
Cf-250	$2 \times 10^1$	$2 \times 10^{-3}$	$1 \times 10^1$	$1 \times 10^4$
Cf-251	$7 \times 10^0$	$7 \times 10^{-4}$	$1 \times 10^0$	$1 \times 10^3$
Cf-252	$1 \times 10^{-1}$	$3 \times 10^{-3}$	$1 \times 10^1$	$1 \times 10^4$
Cf-253 (a)	$4 \times 10^1$	$4 \times 10^{-2}$	$1 \times 10^2$	$1 \times 10^5$
Cf-254	$1 \times 10^{-3}$	$1 \times 10^{-3}$	$1 \times 10^0$	$1 \times 10^3$
Chlorine (17)				
Cl-36	$1 \times 10^1$	$6 \times 10^{-1}$	$1 \times 10^4$	$1 \times 10^6$

For footnotes see pp. 43–46

TABLE 2. BASIC RADIONUCLIDE VALUES (cont.)

Radionuclide (atomic number)	$A_1$	$A_2$	Activity concentration limit for exempt material	Activity limit for an exempt <i>consignment</i>
(TBq)		(TBq)	(Bq/g)	(Bq)
Cl-38	$2 \times 10^{-1}$	$2 \times 10^{-1}$	$1 \times 10^1$	$1 \times 10^5$
Curium (96)				
Cm-240	$4 \times 10^1$	$2 \times 10^{-2}$	$1 \times 10^2$	$1 \times 10^5$
Cm-241	$2 \times 10^0$	$1 \times 10^0$	$1 \times 10^2$	$1 \times 10^6$
Cm-242	$4 \times 10^1$	$1 \times 10^{-2}$	$1 \times 10^2$	$1 \times 10^5$
Cm-243	$9 \times 10^0$	$1 \times 10^{-3}$	$1 \times 10^0$	$1 \times 10^4$
Cm-244	$2 \times 10^1$	$2 \times 10^{-3}$	$1 \times 10^1$	$1 \times 10^4$
Cm-245	$9 \times 10^0$	$9 \times 10^{-4}$	$1 \times 10^0$	$1 \times 10^3$
Cm-246	$9 \times 10^0$	$9 \times 10^{-4}$	$1 \times 10^0$	$1 \times 10^3$
Cm-247 (a)	$3 \times 10^0$	$1 \times 10^{-3}$	$1 \times 10^0$	$1 \times 10^4$
Cm-248	$2 \times 10^{-2}$	$3 \times 10^{-4}$	$1 \times 10^0$	$1 \times 10^3$
Cobalt (27)				
Co-55	$5 \times 10^{-1}$	$5 \times 10^{-1}$	$1 \times 10^1$	$1 \times 10^6$
Co-56	$3 \times 10^{-1}$	$3 \times 10^{-1}$	$1 \times 10^1$	$1 \times 10^5$
Co-57	$1 \times 10^1$	$1 \times 10^1$	$1 \times 10^2$	$1 \times 10^6$
Co-58	$1 \times 10^0$	$1 \times 10^0$	$1 \times 10^1$	$1 \times 10^6$
Co-58m	$4 \times 10^1$	$4 \times 10^1$	$1 \times 10^4$	$1 \times 10^7$
Co-60	$4 \times 10^{-1}$	$4 \times 10^{-1}$	$1 \times 10^1$	$1 \times 10^5$
Chromium (24)				
Cr-51	$3 \times 10^1$	$3 \times 10^1$	$1 \times 10^3$	$1 \times 10^7$
Caesium (55)				
Cs-129	$4 \times 10^0$	$4 \times 10^0$	$1 \times 10^2$	$1 \times 10^5$
Cs-131	$3 \times 10^1$	$3 \times 10^1$	$1 \times 10^3$	$1 \times 10^6$
Cs-132	$1 \times 10^0$	$1 \times 10^0$	$1 \times 10^1$	$1 \times 10^5$
Cs-134	$7 \times 10^{-1}$	$7 \times 10^{-1}$	$1 \times 10^1$	$1 \times 10^4$
Cs-134m	$4 \times 10^1$	$6 \times 10^{-1}$	$1 \times 10^3$	$1 \times 10^5$
Cs-135	$4 \times 10^1$	$1 \times 10^0$	$1 \times 10^4$	$1 \times 10^7$
Cs-136	$5 \times 10^{-1}$	$5 \times 10^{-1}$	$1 \times 10^1$	$1 \times 10^5$

-----

TABLE 2. BASIC RADIONUCLIDE VALUES (cont.)

Radionuclide (atomic number)	A1	A2	Activity concentration limit for exempt material	Activity limit for an exempt <i>consignment</i>
	(TBq)	(TBq)	(Bq/g)	(Bq)
Cs-137 (a)	$2 \times 10^0$	$6 \times 10^{-1}$	$1 \times 10^1$ (b)	$1 \times 10^4$ (b)
Copper (29)				
Cu-64	$6 \times 10^0$	$1 \times 10^0$	$1 \times 10^2$	$1 \times 10^6$
Cu-67	$1 \times 10^1$	$7 \times 10^{-1}$	$1 \times 10^2$	$1 \times 10^6$
Dysprosium (66)				
Dy-159	$2 \times 10^1$	$2 \times 10^1$	$1 \times 10^3$	$1 \times 10^7$
Dy-165	$9 \times 10^{-1}$	$6 \times 10^{-1}$	$1 \times 10^3$	$1 \times 10^6$
Dy-166 (a)	$9 \times 10^{-1}$	$3 \times 10^{-1}$	$1 \times 10^3$	$1 \times 10^6$
Erbium (68)				
Er-169	$4 \times 10^1$	$1 \times 10^0$	$1 \times 10^4$	$1 \times 10^7$
Er-171	$8 \times 10^{-1}$	$5 \times 10^{-1}$	$1 \times 10^2$	$1 \times 10^6$
Europium (63)				
Eu-147	$2 \times 10^0$	$2 \times 10^0$	$1 \times 10^2$	$1 \times 10^6$
Eu-148	$5 \times 10^{-1}$	$5 \times 10^{-1}$	$1 \times 10^1$	$1 \times 10^6$
Eu-149	$2 \times 10^1$	$2 \times 10^1$	$1 \times 10^2$	$1 \times 10^7$
Eu-150 (short lived)	$2 \times 10^0$	$7 \times 10^{-1}$	$1 \times 10^3$	$1 \times 10^6$
Eu-150 (long lived)	$7 \times 10^{-1}$	$7 \times 10^{-1}$	$1 \times 10^1$	$1 \times 10^6$
Eu-152	$1 \times 10^0$	$1 \times 10^0$	$1 \times 10^1$	$1 \times 10^6$
Eu-152m	$8 \times 10^{-1}$	$8 \times 10^{-1}$	$1 \times 10^2$	$1 \times 10^6$
Eu-154	$9 \times 10^{-1}$	$6 \times 10^{-1}$	$1 \times 10^1$	$1 \times 10^6$
Eu-155	$2 \times 10^1$	$3 \times 10^0$	$1 \times 10^2$	$1 \times 10^7$
Eu-156	$7 \times 10^{-1}$	$7 \times 10^{-1}$	$1 \times 10^1$	$1 \times 10^6$
Fluorine (9)				
F-18	$1 \times 10^0$	$6 \times 10^{-1}$	$1 \times 10^1$	$1 \times 10^6$
Iron (26)				
Fe-52 (a)	$3 \times 10^{-1}$	$3 \times 10^{-1}$	$1 \times 10^1$	$1 \times 10^6$
Fe-55	$4 \times 10^1$	$4 \times 10^1$	$1 \times 10^4$	$1 \times 10^6$

For footnotes see pp. 43–46

TABLE 2. BASIC RADIONUCLIDE VALUES (cont.)

Radionuclide (atomic number)	$A_1$	$A_2$	Activity concentration limit for exempt material	Activity limit for an exempt <i>consignment</i>
(TBq)		(TBq)	(Bq/g)	(Bq)
Fe-59	$9 \times 10^{-1}$	$9 \times 10^{-1}$	$1 \times 10^1$	$1 \times 10^6$
Fe-60 (a)	$4 \times 10^1$	$2 \times 10^{-1}$	$1 \times 10^2$	$1 \times 10^5$
Gallium (31)				
Ga-67	$7 \times 10^0$	$3 \times 10^0$	$1 \times 10^2$	$1 \times 10^6$
Ga-68	$5 \times 10^{-1}$	$5 \times 10^{-1}$	$1 \times 10^1$	$1 \times 10^5$
Ga-72	$4 \times 10^{-1}$	$4 \times 10^{-1}$	$1 \times 10^1$	$1 \times 10^5$
Gadolinium (64)				
Gd-146 (a)	$5 \times 10^{-1}$	$5 \times 10^{-1}$	$1 \times 10^1$	$1 \times 10^6$
Gd-148	$2 \times 10^1$	$2 \times 10^{-3}$	$1 \times 10^1$	$1 \times 10^4$
Gd-153	$1 \times 10^1$	$9 \times 10^0$	$1 \times 10^2$	$1 \times 10^7$
Gd-159	$3 \times 10^0$	$6 \times 10^{-1}$	$1 \times 10^3$	$1 \times 10^6$
Germanium (32)				
Ge-68 (a)	$5 \times 10^{-1}$	$5 \times 10^{-1}$	$1 \times 10^1$	$1 \times 10^5$
Ge-69	$1 \times 10^0$	$1 \times 10^0$	$1 \times 10^2$	$1 \times 10^6$
Ge-71	$4 \times 10^1$	$4 \times 10^1$	$1 \times 10^4$	$1 \times 10^8$
Ge-77	$3 \times 10^{-1}$	$3 \times 10^{-1}$	$1 \times 10^1$	$1 \times 10^5$
Hafnium (72)				
Hf-172 (a)	$6 \times 10^{-1}$	$6 \times 10^{-1}$	$1 \times 10^1$	$1 \times 10^6$
Hf-175	$3 \times 10^0$	$3 \times 10^0$	$1 \times 10^2$	$1 \times 10^6$
Hf-181	$2 \times 10^0$	$5 \times 10^{-1}$	$1 \times 10^1$	$1 \times 10^6$
Hf-182	Unlimited	Unlimited	$1 \times 10^2$	$1 \times 10^6$
Mercury (80)				
Hg-194 (a)	$1 \times 10^0$	$1 \times 10^0$	$1 \times 10^1$	$1 \times 10^6$
Hg-195m (a)	$3 \times 10^0$	$7 \times 10^{-1}$	$1 \times 10^2$	$1 \times 10^6$
Hg-197	$2 \times 10^1$	$1 \times 10^1$	$1 \times 10^2$	$1 \times 10^7$
Hg-197m	$1 \times 10^1$	$4 \times 10^{-1}$	$1 \times 10^2$	$1 \times 10^6$
Hg-203	$5 \times 10^0$	$1 \times 10^0$	$1 \times 10^2$	$1 \times 10^5$
Holmium (67)				
Ho-166	$4 \times 10^{-1}$	$4 \times 10^{-1}$	$1 \times 10^3$	$1 \times 10^5$

TABLE 2. BASIC RADIONUCLIDE VALUES (cont.)

Radionuclide (atomic number)	$A_1$	$A_2$	Activity concentration limit for exempt material	Activity limit for an exempt <i>consignment</i>
(TBq)		(TBq)	(Bq/g)	(Bq)
Ho-166m	$6 \times 10^{-1}$	$5 \times 10^{-1}$	$1 \times 10^1$	$1 \times 10^6$
Iodine (53)				
I-123	$6 \times 10^0$	$3 \times 10^0$	$1 \times 10^2$	$1 \times 10^7$
I-124	$1 \times 10^0$	$1 \times 10^0$	$1 \times 10^1$	$1 \times 10^6$
I-125	$2 \times 10^1$	$3 \times 10^0$	$1 \times 10^3$	$1 \times 10^6$
I-126	$2 \times 10^0$	$1 \times 10^0$	$1 \times 10^2$	$1 \times 10^6$
I-129	Unlimited	Unlimited	$1 \times 10^2$	$1 \times 10^5$
I-131	$3 \times 10^0$	$7 \times 10^{-1}$	$1 \times 10^2$	$1 \times 10^6$
I-132	$4 \times 10^{-1}$	$4 \times 10^{-1}$	$1 \times 10^1$	$1 \times 10^5$
I-133	$7 \times 10^{-1}$	$6 \times 10^{-1}$	$1 \times 10^1$	$1 \times 10^6$
I-134	$3 \times 10^{-1}$	$3 \times 10^{-1}$	$1 \times 10^1$	$1 \times 10^5$
I-135 (a)	$6 \times 10^{-1}$	$6 \times 10^{-1}$	$1 \times 10^1$	$1 \times 10^6$
Indium (49)				
In-111	$3 \times 10^0$	$3 \times 10^0$	$1 \times 10^2$	$1 \times 10^6$
In-113m	$4 \times 10^0$	$2 \times 10^0$	$1 \times 10^2$	$1 \times 10^6$
In-114m (a)	$1 \times 10^1$	$5 \times 10^{-1}$	$1 \times 10^2$	$1 \times 10^6$
In-115m	$7 \times 10^0$	$1 \times 10^0$	$1 \times 10^2$	$1 \times 10^6$
Iridium (77)				
Ir-189 (a)	$1 \times 10^1$	$1 \times 10^1$	$1 \times 10^2$	$1 \times 10^7$
Ir-190	$7 \times 10^{-1}$	$7 \times 10^{-1}$	$1 \times 10^1$	$1 \times 10^6$
Ir-192	$1 \times 10^0$ (c)	$6 \times 10^{-1}$	$1 \times 10^1$	$1 \times 10^4$
<b>Ir-193m</b>	<b><math>4 \times 10^1</math></b>	<b><math>4 \times 10^0</math></b>	<b><math>1 \times 10^1</math></b>	<b><math>1 \times 10^4</math></b>
Ir-194	$3 \times 10^{-1}$	$3 \times 10^{-1}$	$1 \times 10^2$	$1 \times 10^5$
Potassium (19)				
K-40	$9 \times 10^{-1}$	$9 \times 10^{-1}$	$1 \times 10^2$	$1 \times 10^6$
K-42	$2 \times 10^{-1}$	$2 \times 10^{-1}$	$1 \times 10^2$	$1 \times 10^6$
K-43	$7 \times 10^{-1}$	$6 \times 10^{-1}$	$1 \times 10^1$	$1 \times 10^6$

For footnotes see pp. 43–46

TABLE 2. BASIC RADIONUCLIDE VALUES (cont.)

Radionuclide (atomic number)	$A_1$	$A_2$	Activity concentration limit for exempt material	Activity limit for an exempt <i>consignment</i>
(TBq)		(TBq)	(Bq/g)	(Bq)
Krypton (36)				
Kr-79	$4 \times 10^0$	$2 \times 10^0$	$1 \times 10^3$	$1 \times 10^5$
Kr-81	$4 \times 10^1$	$4 \times 10^1$	$1 \times 10^4$	$1 \times 10^7$
Kr-85	$1 \times 10^1$	$1 \times 10^1$	$1 \times 10^5$	$1 \times 10^4$
Kr-85m	$8 \times 10^0$	$3 \times 10^0$	$1 \times 10^3$	$1 \times 10^{10}$
Kr-87	$2 \times 10^{-1}$	$2 \times 10^{-1}$	$1 \times 10^2$	$1 \times 10^9$
Lanthanum (57)				
La-137	$3 \times 10^1$	$6 \times 10^0$	$1 \times 10^3$	$1 \times 10^7$
La-140	$4 \times 10^{-1}$	$4 \times 10^{-1}$	$1 \times 10^1$	$1 \times 10^5$
Lutetium (71)				
Lu-172	$6 \times 10^{-1}$	$6 \times 10^{-1}$	$1 \times 10^1$	$1 \times 10^6$
Lu-173	$8 \times 10^0$	$8 \times 10^0$	$1 \times 10^2$	$1 \times 10^7$
Lu-174	$9 \times 10^0$	$9 \times 10^0$	$1 \times 10^2$	$1 \times 10^7$
Lu-174m	$2 \times 10^1$	$1 \times 10^1$	$1 \times 10^2$	$1 \times 10^7$
Lu-177	$3 \times 10^1$	$7 \times 10^{-1}$	$1 \times 10^3$	$1 \times 10^7$
Magnesium (12)				
Mg-28 (a)	$3 \times 10^{-1}$	$3 \times 10^{-1}$	$1 \times 10^1$	$1 \times 10^5$
Manganese (25)				
Mn-52	$3 \times 10^{-1}$	$3 \times 10^{-1}$	$1 \times 10^1$	$1 \times 10^5$
Mn-53	Unlimited	Unlimited	$1 \times 10^4$	$1 \times 10^9$
Mn-54	$1 \times 10^0$	$1 \times 10^0$	$1 \times 10^1$	$1 \times 10^6$
Mn-56	$3 \times 10^{-1}$	$3 \times 10^{-1}$	$1 \times 10^1$	$1 \times 10^5$
Molybdenum (42)				
Mo-93	$4 \times 10^1$	$2 \times 10^1$	$1 \times 10^3$	$1 \times 10^8$
Mo-99 (a)	$1 \times 10^0$	$6 \times 10^{-1}$	$1 \times 10^2$	$1 \times 10^6$
Nitrogen (7)				
N-13	$9 \times 10^{-1}$	$6 \times 10^{-1}$	$1 \times 10^2$	$1 \times 10^9$

TABLE 2. BASIC RADIONUCLIDE VALUES (cont.)

Radionuclide (atomic number)	A1	A2	Activity concentration limit for exempt material	Activity limit for an exempt <i>consignment</i>
	(TBq)	(TBq)	(Bq/g)	(Bq)
<b>Sodium (11)</b>				
Na-22	$5 \times 10^{-1}$	$5 \times 10^{-1}$	$1 \times 10^1$	$1 \times 10^6$
Na-24	$2 \times 10^{-1}$	$2 \times 10^{-1}$	$1 \times 10^1$	$1 \times 10^5$
<b>Niobium (41)</b>				
Nb-93m	$4 \times 10^1$	$3 \times 10^1$	$1 \times 10^4$	$1 \times 10^7$
Nb-94	$7 \times 10^{-1}$	$7 \times 10^{-1}$	$1 \times 10^1$	$1 \times 10^6$
Nb-95	$1 \times 10^0$	$1 \times 10^0$	$1 \times 10^1$	$1 \times 10^6$
Nb-97	$9 \times 10^{-1}$	$6 \times 10^{-1}$	$1 \times 10^1$	$1 \times 10^6$
<b>Neodymium (60)</b>				
Nd-147	$6 \times 10^0$	$6 \times 10^{-1}$	$1 \times 10^2$	$1 \times 10^6$
Nd-149	$6 \times 10^{-1}$	$5 \times 10^{-1}$	$1 \times 10^2$	$1 \times 10^6$
<b>Nickel (28)</b>				
<u>Ni-57</u>	<u><math>6 \times 10^{-1}</math></u>	<u><math>6 \times 10^{-1}</math></u>	<u><math>1 \times 10^4</math></u>	<u><math>1 \times 10^7</math></u>
Ni-59	Unlimited	Unlimited	$1 \times 10^4$	$1 \times 10^8$
Ni-63	$4 \times 10^1$	$3 \times 10^1$	$1 \times 10^5$	$1 \times 10^8$
Ni-65	$4 \times 10^{-1}$	$4 \times 10^{-1}$	$1 \times 10^1$	$1 \times 10^6$
<b>Neptunium (93)</b>				
Np-235	$4 \times 10^1$	$4 \times 10^1$	$1 \times 10^3$	$1 \times 10^7$
Np-236 (short lived)	$2 \times 10^1$	$2 \times 10^0$	$1 \times 10^3$	$1 \times 10^7$
Np-236 (long lived)	$9 \times 10^0$	$2 \times 10^{-2}$	$1 \times 10^2$	$1 \times 10^5$
Np-237	$2 \times 10^1$	$2 \times 10^{-3}$	$1 \times 10^0$ (b)	$1 \times 10^3$ (b)
Np-239	$7 \times 10^0$	$4 \times 10^{-1}$	$1 \times 10^2$	$1 \times 10^7$
<b>Osmium (76)</b>				
Os-185	$1 \times 10^0$	$1 \times 10^0$	$1 \times 10^1$	$1 \times 10^6$
Os-191	$1 \times 10^1$	$2 \times 10^0$	$1 \times 10^2$	$1 \times 10^7$
Os-191m	$4 \times 10^1$	$3 \times 10^1$	$1 \times 10^3$	$1 \times 10^7$
Os-193	$2 \times 10^0$	$6 \times 10^{-1}$	$1 \times 10^2$	$1 \times 10^6$
Os-194 (a)	$3 \times 10^{-1}$	$3 \times 10^{-1}$	$1 \times 10^2$	$1 \times 10^5$

For footnotes see pp. 43–46

TABLE 2. BASIC RADIONUCLIDE VALUES (cont.)

Radionuclide (atomic number)	<i>A1</i>	<i>A2</i>	Activity concentration limit for exempt material	Activity limit for an exempt <i>consignment</i>
	(TBq)	(TBq)	(Bq/g)	(Bq)
Phosphorus (15)				
P-32	$5 \times 10^{-1}$	$5 \times 10^{-1}$	$1 \times 10^3$	$1 \times 10^5$
P-33	$4 \times 10^1$	$1 \times 10^0$	$1 \times 10^5$	$1 \times 10^8$
Protactinium (91)				
Pa-230 (a)	$2 \times 10^0$	$7 \times 10^{-2}$	$1 \times 10^1$	$1 \times 10^6$
Pa-231	$4 \times 10^0$	$4 \times 10^{-4}$	$1 \times 10^0$	$1 \times 10^3$
Pa-233	$5 \times 10^0$	$7 \times 10^{-1}$	$1 \times 10^2$	$1 \times 10^7$
Lead (82)				
Pb-201	$1 \times 10^0$	$1 \times 10^0$	$1 \times 10^1$	$1 \times 10^6$
Pb-202	$4 \times 10^1$	$2 \times 10^1$	$1 \times 10^3$	$1 \times 10^6$
Pb-203	$4 \times 10^0$	$3 \times 10^0$	$1 \times 10^2$	$1 \times 10^6$
Pb-205	Unlimited	Unlimited	$1 \times 10^4$	$1 \times 10^7$
Pb-210 (a)	$1 \times 10^0$	$5 \times 10^{-2}$	$1 \times 10^1$ (b)	$1 \times 10^4$ (b)
Pb-212 (a)	$7 \times 10^{-1}$	$2 \times 10^{-1}$	$1 \times 10^1$ (b)	$1 \times 10^5$ (b)
Palladium (46)				
Pd-103 (a)	$4 \times 10^1$	$4 \times 10^1$	$1 \times 10^3$	$1 \times 10^8$
Pd-107	Unlimited	Unlimited	$1 \times 10^5$	$1 \times 10^8$
Pd-109	$2 \times 10^0$	$5 \times 10^{-1}$	$1 \times 10^3$	$1 \times 10^6$
Promethium (61)				
Pm-143	$3 \times 10^0$	$3 \times 10^0$	$1 \times 10^2$	$1 \times 10^6$
Pm-144	$7 \times 10^{-1}$	$7 \times 10^{-1}$	$1 \times 10^1$	$1 \times 10^6$
Pm-145	$3 \times 10^1$	$1 \times 10^1$	$1 \times 10^3$	$1 \times 10^7$
Pm-147	$4 \times 10^1$	$2 \times 10^0$	$1 \times 10^4$	$1 \times 10^7$
Pm-148m (a)	$8 \times 10^{-1}$	$7 \times 10^{-1}$	$1 \times 10^1$	$1 \times 10^6$
Pm-149	$2 \times 10^0$	$6 \times 10^{-1}$	$1 \times 10^3$	$1 \times 10^6$
Pm-151	$2 \times 10^0$	$6 \times 10^{-1}$	$1 \times 10^2$	$1 \times 10^6$

TABLE 2. BASIC RADIONUCLIDE VALUES (cont.)

Radionuclide (atomic number)	<i>A1</i>	<i>A2</i>	Activity concentration limit for exempt material	Activity limit for an exempt <i>consignment</i>
	(TBq)	(TBq)	(Bq/g)	(Bq)
Polonium (84)				
Po-210	$4 \times 10^1$	$2 \times 10^{-2}$	$1 \times 10^1$	$1 \times 10^4$
Praseodymium (59)				
Pr-142	$4 \times 10^{-1}$	$4 \times 10^{-1}$	$1 \times 10^2$	$1 \times 10^5$
Pr-143	$3 \times 10^0$	$6 \times 10^{-1}$	$1 \times 10^4$	$1 \times 10^6$
Platinum (78)				
Pt-188 (a)	$1 \times 10^0$	$8 \times 10^{-1}$	$1 \times 10^1$	$1 \times 10^6$
Pt-191	$4 \times 10^0$	$3 \times 10^0$	$1 \times 10^2$	$1 \times 10^6$
Pt-193	$4 \times 10^1$	$4 \times 10^1$	$1 \times 10^4$	$1 \times 10^7$
Pt-193m	$4 \times 10^1$	$5 \times 10^{-1}$	$1 \times 10^3$	$1 \times 10^7$
Pt-195m	$1 \times 10^1$	$5 \times 10^{-1}$	$1 \times 10^2$	$1 \times 10^6$
Pt-197	$2 \times 10^1$	$6 \times 10^{-1}$	$1 \times 10^3$	$1 \times 10^6$
Pt-197m	$1 \times 10^1$	$6 \times 10^{-1}$	$1 \times 10^2$	$1 \times 10^6$
Plutonium (94)				
Pu-236	$3 \times 10^1$	$3 \times 10^{-3}$	$1 \times 10^1$	$1 \times 10^4$
Pu-237	$2 \times 10^1$	$2 \times 10^1$	$1 \times 10^3$	$1 \times 10^7$
Pu-238	$1 \times 10^1$	$1 \times 10^{-3}$	$1 \times 10^0$	$1 \times 10^4$
Pu-239	$1 \times 10^1$	$1 \times 10^{-3}$	$1 \times 10^0$	$1 \times 10^4$
Pu-240	$1 \times 10^1$	$1 \times 10^{-3}$	$1 \times 10^0$	$1 \times 10^3$
Pu-241 (a)	$4 \times 10^1$	$6 \times 10^{-2}$	$1 \times 10^2$	$1 \times 10^5$
Pu-242	$1 \times 10^1$	$1 \times 10^{-3}$	$1 \times 10^0$	$1 \times 10^4$
Pu-244 (a)	$4 \times 10^{-1}$	$1 \times 10^{-3}$	$1 \times 10^0$	$1 \times 10^4$
Radium (88)				
Ra-223 (a)	$4 \times 10^{-1}$	$7 \times 10^{-3}$	$1 \times 10^2$ (b)	$1 \times 10^5$ (b)
Ra-224 (a)	$4 \times 10^{-1}$	$2 \times 10^{-2}$	$1 \times 10^1$ (b)	$1 \times 10^5$ (b)
Ra-225 (a)	$2 \times 10^{-1}$	$4 \times 10^{-3}$	$1 \times 10^2$	$1 \times 10^5$

For footnotes see pp. 43–46

TABLE 2. BASIC RADIONUCLIDE VALUES (cont.)

Radionuclide (atomic number)	<i>A1</i>	<i>A2</i>	Activity concentration limit for exempt material	Activity limit for an exempt <i>consignment</i>
	(TBq)	(TBq)	(Bq/g)	(Bq)
Ra-226 (a)	$2 \times 10^{-1}$	$3 \times 10^{-3}$	$1 \times 10^1$ (b)	$1 \times 10^4$ (b)
Ra-228 (a)	$6 \times 10^{-1}$	$2 \times 10^{-2}$	$1 \times 10^1$ (b)	$1 \times 10^5$ (b)
Rubidium (37)				
Rb-81	$2 \times 10^0$	$8 \times 10^{-1}$	$1 \times 10^1$	$1 \times 10^6$
Rb-83 (a)	$2 \times 10^0$	$2 \times 10^0$	$1 \times 10^2$	$1 \times 10^6$
Rb-84	$1 \times 10^0$	$1 \times 10^0$	$1 \times 10^1$	$1 \times 10^6$
Rb-86	$5 \times 10^{-1}$	$5 \times 10^{-1}$	$1 \times 10^2$	$1 \times 10^5$
Rb-87	Unlimited	Unlimited	$1 \times 10^4$	$1 \times 10^7$
Rb (natural)	Unlimited	Unlimited	$1 \times 10^4$	$1 \times 10^7$
Rhenium (75)				
Re-184	$1 \times 10^0$	$1 \times 10^0$	$1 \times 10^1$	$1 \times 10^6$
Re-184m	$3 \times 10^0$	$1 \times 10^0$	$1 \times 10^2$	$1 \times 10^6$
Re-186	$2 \times 10^0$	$6 \times 10^{-1}$	$1 \times 10^3$	$1 \times 10^6$
Re-187	Unlimited	Unlimited	$1 \times 10^6$	$1 \times 10^9$
Re-188	$4 \times 10^{-1}$	$4 \times 10^{-1}$	$1 \times 10^2$	$1 \times 10^5$
Re-189 (a)	$3 \times 10^0$	$6 \times 10^{-1}$	$1 \times 10^2$	$1 \times 10^6$
Re (natural)	Unlimited	Unlimited	$1 \times 10^6$	$1 \times 10^9$
Rhodium (45)				
Rh-99	$2 \times 10^0$	$2 \times 10^0$	$1 \times 10^1$	$1 \times 10^6$
Rh-101	$4 \times 10^0$	$3 \times 10^0$	$1 \times 10^2$	$1 \times 10^7$
Rh-102	$5 \times 10^{-1}$	$5 \times 10^{-1}$	$1 \times 10^1$	$1 \times 10^6$
Rh-102m	$2 \times 10^0$	$2 \times 10^0$	$1 \times 10^2$	$1 \times 10^6$
Rh-103m	$4 \times 10^1$	$4 \times 10^1$	$1 \times 10^4$	$1 \times 10^8$
Rh-105	$1 \times 10^1$	$8 \times 10^{-1}$	$1 \times 10^2$	$1 \times 10^7$
Radon (86)				
Rn-222 (a)	$3 \times 10^{-1}$	$4 \times 10^{-3}$	$1 \times 10^1$ (b)	$1 \times 10^8$ (b)

TABLE 2. BASIC RADIONUCLIDE VALUES (cont.)

Radionuclide (atomic number)	<i>A1</i>	<i>A2</i>	Activity concentration limit for exempt material	Activity limit for an exempt <i>consignment</i>
	(TBq)	(TBq)	(Bq/g)	(Bq)
Ruthenium (44)				
Ru-97	$5 \times 10^0$	$5 \times 10^0$	$1 \times 10^2$	$1 \times 10^7$
Ru-103 (a)	$2 \times 10^0$	$2 \times 10^0$	$1 \times 10^2$	$1 \times 10^6$
Ru-105	$1 \times 10^0$	$6 \times 10^{-1}$	$1 \times 10^1$	$1 \times 10^6$
Ru-106 (a)	$2 \times 10^{-1}$	$2 \times 10^{-1}$	$1 \times 10^2$ (b)	$1 \times 10^5$ (b)
Sulphur (16)				
S-35	$4 \times 10^1$	$3 \times 10^0$	$1 \times 10^5$	$1 \times 10^8$
Antimony (51)				
Sb-122	$4 \times 10^{-1}$	$4 \times 10^{-1}$	$1 \times 10^2$	$1 \times 10^4$
Sb-124	$6 \times 10^{-1}$	$6 \times 10^{-1}$	$1 \times 10^1$	$1 \times 10^6$
Sb-125	$2 \times 10^0$	$1 \times 10^0$	$1 \times 10^2$	$1 \times 10^6$
Sb-126	$4 \times 10^{-1}$	$4 \times 10^{-1}$	$1 \times 10^1$	$1 \times 10^5$
Scandium (21)				
Sc-44	$5 \times 10^{-1}$	$5 \times 10^{-1}$	$1 \times 10^1$	$1 \times 10^5$
Sc-46	$5 \times 10^{-1}$	$5 \times 10^{-1}$	$1 \times 10^1$	$1 \times 10^6$
Sc-47	$1 \times 10^1$	$7 \times 10^{-1}$	$1 \times 10^2$	$1 \times 10^6$
Sc-48	$3 \times 10^{-1}$	$3 \times 10^{-1}$	$1 \times 10^1$	$1 \times 10^5$
Selenium (34)				
Se-75	$3 \times 10^0$	$3 \times 10^0$	$1 \times 10^2$	$1 \times 10^6$
Se-79	$4 \times 10^1$	$2 \times 10^0$	$1 \times 10^4$	$1 \times 10^7$
Silicon (14)				
Si-31	$6 \times 10^{-1}$	$6 \times 10^{-1}$	$1 \times 10^3$	$1 \times 10^6$
Si-32	$4 \times 10^1$	$5 \times 10^{-1}$	$1 \times 10^3$	$1 \times 10^6$
Samarium (62)				
Sm-145	$1 \times 10^1$	$1 \times 10^1$	$1 \times 10^2$	$1 \times 10^7$
Sm-147	Unlimited	Unlimited	$1 \times 10^1$	$1 \times 10^4$

For footnotes see pp. 43–46

TABLE 2. BASIC RADIONUCLIDE VALUES (cont.)

Radionuclide (atomic number)	A1	A2	Activity concentration limit for exempt material	Activity limit for an exempt <i>consignment</i>
	(TBq)	(TBq)	(Bq/g)	(Bq)
Sm-151	$4 \times 10^1$	$1 \times 10^1$	$1 \times 10^4$	$1 \times 10^8$
Sm-153	$9 \times 10^0$	$6 \times 10^{-1}$	$1 \times 10^2$	$1 \times 10^6$
Tin (50)				
Sn-113 (a)	$4 \times 10^0$	$2 \times 10^0$	$1 \times 10^3$	$1 \times 10^7$
Sn-117m	$7 \times 10^0$	$4 \times 10^{-1}$	$1 \times 10^2$	$1 \times 10^6$
Sn-119m	$4 \times 10^1$	$3 \times 10^1$	$1 \times 10^3$	$1 \times 10^7$
Sn-121m (a)	$4 \times 10^1$	$9 \times 10^{-1}$	$1 \times 10^3$	$1 \times 10^7$
Sn-123	$8 \times 10^{-1}$	$6 \times 10^{-1}$	$1 \times 10^3$	$1 \times 10^6$
Sn-125	$4 \times 10^{-1}$	$4 \times 10^{-1}$	$1 \times 10^2$	$1 \times 10^5$
Sn-126 (a)	$6 \times 10^{-1}$	$4 \times 10^{-1}$	$1 \times 10^1$	$1 \times 10^5$
Strontium (38)				
Sr-82 (a)	$2 \times 10^{-1}$	$2 \times 10^{-1}$	$1 \times 10^1$	$1 \times 10^5$
<u>Sr-83</u>	<u><math>1 \times 10^0</math></u>	<u><math>1 \times 10^0</math></u>	<u><math>1 \times 10^1</math></u>	<u><math>1 \times 10^6</math></u>
Sr-85	$2 \times 10^0$	$2 \times 10^0$	$1 \times 10^2$	$1 \times 10^6$
Sr-85m	$5 \times 10^0$	$5 \times 10^0$	$1 \times 10^2$	$1 \times 10^7$
Sr-87m	$3 \times 10^0$	$3 \times 10^0$	$1 \times 10^2$	$1 \times 10^6$
Sr-89	$6 \times 10^{-1}$	$6 \times 10^{-1}$	$1 \times 10^3$	$1 \times 10^6$
Sr-90 (a)	$3 \times 10^{-1}$	$3 \times 10^{-1}$	$1 \times 10^2$ (b)	$1 \times 10^4$ (b)
Sr-91 (a)	$3 \times 10^{-1}$	$3 \times 10^{-1}$	$1 \times 10^1$	$1 \times 10^5$
Sr-92 (a)	$1 \times 10^0$	$3 \times 10^{-1}$	$1 \times 10^1$	$1 \times 10^6$
Tritium (1)				
T(H-3)	$4 \times 10^1$	$4 \times 10^1$	$1 \times 10^6$	$1 \times 10^9$
Tantalum (73)				
Ta-178 (long lived)	$1 \times 10^0$	$8 \times 10^{-1}$	$1 \times 10^1$	$1 \times 10^6$
Ta-179	$3 \times 10^1$	$3 \times 10^1$	$1 \times 10^3$	$1 \times 10^7$
Ta-182	$9 \times 10^{-1}$	$5 \times 10^{-1}$	$1 \times 10^1$	$1 \times 10^4$
Terbium (65)				
Tb-157	$4 \times 10^1$	$4 \times 10^1$	$1 \times 10^4$	$1 \times 10^7$
Tb-158	$1 \times 10^0$	$1 \times 10^0$	$1 \times 10^1$	$1 \times 10^6$

TABLE 2. BASIC RADIONUCLIDE VALUES (cont.)

Radionuclide (atomic number)		A1	A2	Activity concentration limit for exempt material	Activity limit for an exempt <i>consignment</i>
		(TBq)	(TBq)	(Bq/g)	(Bq)
Tb-160	$1 \times 10^0$		$6 \times 10^{-1}$	$1 \times 10^1$	$1 \times 10^6$
Technetium (43)					
Tc-95m (a)	$2 \times 10^0$		$2 \times 10^0$	$1 \times 10^1$	$1 \times 10^6$
Tc-96	$4 \times 10^{-1}$		$4 \times 10^{-1}$	$1 \times 10^1$	$1 \times 10^6$
Tc-96m (a)	$4 \times 10^{-1}$		$4 \times 10^{-1}$	$1 \times 10^3$	$1 \times 10^7$
Tc-97	Unlimited		Unlimited	$1 \times 10^3$	$1 \times 10^8$
Tc-97m	$4 \times 10^1$		$1 \times 10^0$	$1 \times 10^3$	$1 \times 10^7$
Tc-98	$8 \times 10^{-1}$		$7 \times 10^{-1}$	$1 \times 10^1$	$1 \times 10^6$
Tc-99	$4 \times 10^1$		$9 \times 10^{-1}$	$1 \times 10^4$	$1 \times 10^7$
Tc-99m	$1 \times 10^1$		$4 \times 10^0$	$1 \times 10^2$	$1 \times 10^7$
Tellurium (52)					
Te-121	$2 \times 10^0$		$2 \times 10^0$	$1 \times 10^1$	$1 \times 10^6$
Te-121m	$5 \times 10^0$		$3 \times 10^0$	$1 \times 10^2$	$1 \times 10^6$
Te-123m	$8 \times 10^0$		$1 \times 10^0$	$1 \times 10^2$	$1 \times 10^7$
Te-125m	$2 \times 10^1$		$9 \times 10^{-1}$	$1 \times 10^3$	$1 \times 10^7$
Te-127	$2 \times 10^1$		$7 \times 10^{-1}$	$1 \times 10^3$	$1 \times 10^6$
Te-127m (a)	$2 \times 10^1$		$5 \times 10^{-1}$	$1 \times 10^3$	$1 \times 10^7$
Te-129	$7 \times 10^{-1}$		$6 \times 10^{-1}$	$1 \times 10^2$	$1 \times 10^6$
Te-129m (a)	$8 \times 10^{-1}$		$4 \times 10^{-1}$	$1 \times 10^3$	$1 \times 10^6$
Te-131m (a)	$7 \times 10^{-1}$		$5 \times 10^{-1}$	$1 \times 10^1$	$1 \times 10^6$
Te-132 (a)	$5 \times 10^{-1}$		$4 \times 10^{-1}$	$1 \times 10^2$	$1 \times 10^7$
Thorium (90)					
Th-227	$1 \times 10^1$		$5 \times 10^{-3}$	$1 \times 10^1$	$1 \times 10^4$
Th-228 (a)	$5 \times 10^{-1}$		$1 \times 10^{-3}$	$1 \times 10^0$ (b)	$1 \times 10^4$ (b)
Th-229	$5 \times 10^0$		$5 \times 10^{-4}$	$1 \times 10^0$ (b)	$1 \times 10^3$ (b)
Th-230	$1 \times 10^1$		$1 \times 10^{-3}$	$1 \times 10^0$	$1 \times 10^4$
Th-231	$4 \times 10^1$		$2 \times 10^{-2}$	$1 \times 10^3$	$1 \times 10^7$

For footnotes see pp. 43–46

TABLE 2. BASIC RADIONUCLIDE VALUES (cont.)

Radionuclide (atomic number)	$A_1$	$A_2$	Activity concentration limit for exempt material	Activity limit for an exempt <i>consignment</i>
(TBq)		(TBq)	(Bq/g)	(Bq)
Th-232	Unlimited	Unlimited	$1 \times 10^1$	$1 \times 10^4$
Th-234 (a)	$3 \times 10^{-1}$	$3 \times 10^{-1}$	$1 \times 10^3$ (b)	$1 \times 10^5$ (b)
Th (natural)	Unlimited	Unlimited	$1 \times 10^0$ (b)	$1 \times 10^3$ (b)
Titanium (22)				
Ti-44 (a)	$5 \times 10^{-1}$	$4 \times 10^{-1}$	$1 \times 10^1$	$1 \times 10^5$
Thallium (81)				
Tl-200	$9 \times 10^{-1}$	$9 \times 10^{-1}$	$1 \times 10^1$	$1 \times 10^6$
Tl-201	$1 \times 10^1$	$4 \times 10^0$	$1 \times 10^2$	$1 \times 10^6$
Tl-202	$2 \times 10^0$	$2 \times 10^0$	$1 \times 10^2$	$1 \times 10^6$
Tl-204	$1 \times 10^1$	$7 \times 10^{-1}$	$1 \times 10^4$	$1 \times 10^4$
Thulium (69)				
Tm-167	$7 \times 10^0$	$8 \times 10^{-1}$	$1 \times 10^2$	$1 \times 10^6$
Tm-170	$3 \times 10^0$	$6 \times 10^{-1}$	$1 \times 10^3$	$1 \times 10^6$
Tm-171	$4 \times 10^1$	$4 \times 10^1$	$1 \times 10^4$	$1 \times 10^8$
Uranium (92)				
U-230 (fast lung absorption) (a)(d)	$4 \times 10^1$	$1 \times 10^{-1}$	$1 \times 10^1$ (b)	$1 \times 10^5$ (b)
U-230 (medium lung absorption) (a)(e)	$4 \times 10^1$	$4 \times 10^{-3}$	$1 \times 10^1$	$1 \times 10^4$
U-230 (slow lung absorption) (a)(f)	$3 \times 10^1$	$3 \times 10^{-3}$	$1 \times 10^1$	$1 \times 10^4$
U-232 (fast lung absorption) (d)	$4 \times 10^1$	$1 \times 10^{-2}$	$1 \times 10^0$ (b)	$1 \times 10^3$ (b)
U-232 (medium lung absorption) (e)	$4 \times 10^1$	$7 \times 10^{-3}$	$1 \times 10^1$	$1 \times 10^4$
U-232 (slow lung absorption) (f)	$1 \times 10^1$	$1 \times 10^{-3}$	$1 \times 10^1$	$1 \times 10^4$
U-233 (fast lung absorption) (d)	$4 \times 10^1$	$9 \times 10^{-2}$	$1 \times 10^1$	$1 \times 10^4$

TABLE 2. BASIC RADIONUCLIDE VALUES (cont.)

Radionuclide (atomic number)	$A_1$	$A_2$	Activity concentration limit for exempt material	Activity limit for an exempt <i>consignment</i>
	(TBq)	(TBq)	(Bq/g)	(Bq)
U-233 (medium lung absorption) (e)	$4 \times 10^1$	$2 \times 10^{-2}$	$1 \times 10^2$	$1 \times 10^5$
U-233 (slow lung absorption) (f)	$4 \times 10^1$	$6 \times 10^{-3}$	$1 \times 10^1$	$1 \times 10^5$
U-234 (fast lung absorption) (d)	$4 \times 10^1$	$9 \times 10^{-2}$	$1 \times 10^1$	$1 \times 10^4$
U-234 (medium lung absorption) (e)	$4 \times 10^1$	$2 \times 10^{-2}$	$1 \times 10^2$	$1 \times 10^5$
U-234 (slow lung absorption) (f)	$4 \times 10^1$	$6 \times 10^{-3}$	$1 \times 10^1$	$1 \times 10^5$
U-235 (all lung absorption types) (a)(d)(e)(f)	Unlimited	Unlimited	$1 \times 10^1$ (b)	$1 \times 10^4$ (b)
U-236 (fast lung absorption) (d)	Unlimited	Unlimited	$1 \times 10^1$	$1 \times 10^4$
U-236 (medium lung absorption) (e)	$4 \times 10^1$	$2 \times 10^{-2}$	$1 \times 10^2$	$1 \times 10^5$
U-236 (slow lung absorption) (f)	$4 \times 10^1$	$6 \times 10^{-3}$	$1 \times 10^1$	$1 \times 10^4$
U-238 (all lung absorption types) (d)(e)(f)	Unlimited	Unlimited	$1 \times 10^1$ (b)	$1 \times 10^4$ (b)
U (natural)	Unlimited	Unlimited	$1 \times 10^0$ (b)	$1 \times 10^3$ (b)
U (enriched to 20% or less) (g)	Unlimited	Unlimited	$1 \times 10^0$	$1 \times 10^3$
U (depleted)	Unlimited	Unlimited	$1 \times 10^0$	$1 \times 10^3$
Vanadium (23)				
V-48	$4 \times 10^{-1}$	$4 \times 10^{-1}$	$1 \times 10^1$	$1 \times 10^5$
V-49	$4 \times 10^1$	$4 \times 10^1$	$1 \times 10^4$	$1 \times 10^7$

For footnotes see pp. 43–46

TABLE 2. BASIC RADIONUCLIDE VALUES (cont.)

Radionuclide (atomic number)	$A_1$	$A_2$	Activity concentration limit for exempt material	Activity limit for an exempt <i>consignment</i>
(TBq)		(TBq)	(Bq/g)	(Bq)
Tungsten (74)				
W-178 (a)	$9 \times 10^0$	$5 \times 10^0$	$1 \times 10^1$	$1 \times 10^6$
W-181	$3 \times 10^1$	$3 \times 10^1$	$1 \times 10^3$	$1 \times 10^7$
W-185	$4 \times 10^1$	$8 \times 10^{-1}$	$1 \times 10^4$	$1 \times 10^7$
W-187	$2 \times 10^0$	$6 \times 10^{-1}$	$1 \times 10^2$	$1 \times 10^6$
W-188 (a)	$4 \times 10^{-1}$	$3 \times 10^{-1}$	$1 \times 10^2$	$1 \times 10^5$
Xenon (54)				
Xe-122 (a)	$4 \times 10^{-1}$	$4 \times 10^{-1}$	$1 \times 10^2$	$1 \times 10^9$
Xe-123	$2 \times 10^0$	$7 \times 10^{-1}$	$1 \times 10^2$	$1 \times 10^9$
Xe-127	$4 \times 10^0$	$2 \times 10^0$	$1 \times 10^3$	$1 \times 10^5$
Xe-131m	$4 \times 10^1$	$4 \times 10^1$	$1 \times 10^4$	$1 \times 10^4$
Xe-133	$2 \times 10^1$	$1 \times 10^1$	$1 \times 10^3$	$1 \times 10^4$
Xe-135	$3 \times 10^0$	$2 \times 10^0$	$1 \times 10^3$	$1 \times 10^{10}$
Yttrium (39)				
Y-87 (a)	$1 \times 10^0$	$1 \times 10^0$	$1 \times 10^1$	$1 \times 10^6$
Y-88	$4 \times 10^{-1}$	$4 \times 10^{-1}$	$1 \times 10^1$	$1 \times 10^6$
Y-90	$3 \times 10^{-1}$	$3 \times 10^{-1}$	$1 \times 10^3$	$1 \times 10^5$
Y-91	$6 \times 10^{-1}$	$6 \times 10^{-1}$	$1 \times 10^3$	$1 \times 10^6$
Y-91m	$2 \times 10^0$	$2 \times 10^0$	$1 \times 10^2$	$1 \times 10^6$
Y-92	$2 \times 10^{-1}$	$2 \times 10^{-1}$	$1 \times 10^2$	$1 \times 10^5$
Y-93	$3 \times 10^{-1}$	$3 \times 10^{-1}$	$1 \times 10^2$	$1 \times 10^5$
Ytterbium (70)				
Yb-169	$4 \times 10^0$	$1 \times 10^0$	$1 \times 10^2$	$1 \times 10^7$
Yb-175	$3 \times 10^1$	$9 \times 10^{-1}$	$1 \times 10^3$	$1 \times 10^7$
Zinc (30)				
Zn-65	$2 \times 10^0$	$2 \times 10^0$	$1 \times 10^1$	$1 \times 10^6$
Zn-69	$3 \times 10^0$	$6 \times 10^{-1}$	$1 \times 10^4$	$1 \times 10^6$
Zn-69m (a)	$3 \times 10^0$	$6 \times 10^{-1}$	$1 \times 10^2$	$1 \times 10^6$

TABLE 2. BASIC RADIONUCLIDE VALUES (cont.)

Radionuclide (atomic number)	<i>A1</i>	<i>A2</i>	Activity concentration limit for exempt material	Activity limit for an exempt <i>consignment</i>
	(TBq)	(TBq)	(Bq/g)	(Bq)
Zirconium (40)				
Zr-88	$3 \times 10^0$	$3 \times 10^0$	$1 \times 10^2$	$1 \times 10^6$
Zr-93	Unlimited	Unlimited	$1 \times 10^3$ (b)	$1 \times 10^7$ (b)
Zr-95 (a)	$2 \times 10^0$	$8 \times 10^{-1}$	$1 \times 10^1$	$1 \times 10^6$
Zr-97 (a)	$4 \times 10^{-1}$	$4 \times 10^{-1}$	$1 \times 10^1$ (b)	$1 \times 10^5$ (b)

(a) *A1* and/or *A2* values for these parent radionuclides include contributions from their progeny with half-lives less than 10 days, as listed in the following:

Mg-28	Al-28
<del>Ar-42</del>	<del>K-42</del>
Ca-47	Sc-47
Ti-44	Sc-44
Fe-52	Mn-52m
Fe-60	Co-60m
Zn-69m	Zn-69
Ge-68	Ga-68
Rb-83	Kr-83m
Sr-82	Rb-82
Sr-90	Y-90
Sr-91	Y-91m
Sr-92	Y-92
Y-87	Sr-87m
Zr-95	Nb-95m
Zr-97	Nb-97m, Nb-97
Mo-99	Tc-99m
Tc-95m	Tc-95
Tc-96m	Tc-96
Ru-103	Rh-103m
Ru-106	Rh-106
Pd-103	Rh-103m
Ag-108m	Ag-108
Ag-110m	Ag-110
Cd-115	In-115m
In-114m	In-114

Table 2, footnote (a) (cont.)

Sn-113	In-113m
Sn-121m	Sn-121
Sn-126	Sb-126m
<del>Te-1118</del>	<del>Sb-118</del>
Te-127m	Te-127
Te-129m	Te-129
Te-131m	Te-131
Te-132	I-132
I-135	Xe-135m
Xe-122	I-122
Cs-137	Ba-137m
Ba-131	Cs-131
Ba-140	La-140
Ce-144	Pr-144m, Pr-144
Pm-148m	Pm-148
Gd-146	Eu-146
Dy-166	Ho-166
Hf-172	Lu-172
W-178	Ta-178
W-188	Re-188
Re-189	Os-189m
Os-194	Ir-194
Ir-189	Os-189m
Pt-188	Ir-188
Hg-194	Au-194
Hg-195m	Hg-195
Pb-210	Bi-210
Pb-212	Bi-212, Tl-208, Po-212
Bi-210m	Tl-206
Bi-212	Tl-208, Po-212
At-211	Po-211
Rn-222	Po-218, Pb-214, At-218, Bi-214, Po-214
Ra-223	Rn-219, Po-215, Pb-211, Bi-211, Po-211, Tl-207
Ra-224	Rn-220, Po-216, Pb-212, Bi-212, Tl-208, Po-212
Ra-225	Ac-225, Fr-221, At-217, Bi-213, Tl-209, Po-213, Pb-209
Ra-226	Rn-222, Po-218, Pb-214, At-218, Bi-214, Po-214
Ra-228	Ac-228
Ac-225	Fr-221, At-217, Bi-213, Tl-209, Po-213, Pb-209
Ac-227	Fr-223
Th-228	Ra-224, Rn-220, Po-216, Pb-212, Bi-212, Tl-208, Po-212
Th-234	Pa-234m, Pa-234
Pa-230	Ac-226, Th-226, Fr-222, Ra-222, Rn-218, Po-214
U-230	Th-226, Ra-222, Rn-218, Po-214
U-235	Th-231

Table 2, footnote (a) (cont.)

Pu-241	U-237
Pu-244	U-240, Np-240m
Am-242m	Am-242, Np-238
Am-243	Np-239
Cm-247	Pu-243
Bk-249	Am-245
Cf-253	Cm-249

(b) Parent nuclides and their progeny included in secular equilibrium are listed in the following (the activity to be taken into account is that of the parent nuclide only):

Sr-90	Y-90
Zr-93	Nb-93m
Zr-97	Nb-97
Ru-106	Rh-106
Ag-108m	Ag-108
Cs-137	Ba-137m
Ce-144	Pr-144
Ba-140	La-140
Bi-212	Tl-208 (0.36), Po-212 (0.64)
Pb-210	Bi-210, Po-210
Pb-212	Bi-212, Tl-208 (0.36), Po-212 (0.64)
Rn-222	Po-218, Pb-214, Bi-214, Po-214
Ra-223	Rn-219, Po-215, Pb-211, Bi-211, Tl-207
Ra-224	Rn-220, Po-216, Pb-212, Bi-212, Tl-208 (0.36), Po-212 (0.64)
Ra-226	Rn-222, Po-218, Pb-214, Bi-214, Po-214, Pb-210, Bi-210, Po-210
Ra-228	Ac-228
Th-228	Ra-224, Rn-220, Po-216, Pb-212, Bi-212, Tl-208 (0.36), Po-212 (0.64)
Th-229	Ra-225, Ac-225, Fr-221, At-217, Bi-213, Po-213, Pb-209
Th-natural*	Ra-228, Ac-228, Th-228, Ra-224, Rn-220, Po-216, Pb-212, Bi-212, Tl-208 (0.36), Po-212 (0.64)
Th-234	Pa-234m
U-230	Th-226, Ra-222, Rn-218, Po-214
U-232 (0.64)	Th-228, Ra-224, Rn-220, Po-216, Pb-212, Bi-212, Tl-208 (0.36), Po-212 (0.64)
U-235	Th-231
U-238	Th-234, Pa-234m
U-natural*	Th-234, Pa-234m, U-234, Th-230, Ra-226, Rn-222, Po-218, Pb-214, Bi-214, Po-214, Pb-210, Bi-210, Po-210
Np-237	Pa-233
Am-242m	Am-242
Am-243	Np-239

\* in the case of Th-natural, the parent nuclide is Th-232, in the case of U-natural the parent nuclide is U-238.

406. When the identity of each radionuclide is known but the individual activities of some of the radionuclides are not known, the radionuclides may be grouped and the lowest radionuclide value, as appropriate for the radionuclides in each group, may be used in applying the formulas in paras 405 and 430. Groups may be based on the total alpha activity and the total beta/gamma activity when these are known, using the lowest radionuclide values for the alpha emitters or beta/gamma emitters, respectively.

407. For individual radionuclides or for mixtures of radionuclides for which relevant data are not available, the values shown in Table 3 shall be used.

TABLE 3. BASIC RADIONUCLIDE VALUES FOR UNKNOWN RADIONUCLIDES OR MIXTURES

<i>Radioactive content</i>	<i>A1</i> (TBq)	<i>A2</i> (TBq)	Activity concentration for material (Bq/g)	Activity limit for an exempt consignment (Bq)
Only beta or gamma emitting nuclides are known to be present	0.1	0.02	$1 \times 10^1$	$1 \times 10^4$
Alpha emitting nuclides, but no neutron emitters are known to be present	0.2	$9 \times 10^{-5}$	$1 \times 10^{-1}$	$1 \times 10^3$
Neutron emitting nuclides are known to be present or no relevant data are available	0.001	$9 \times 10^{-5}$	$1 \times 10^{-1}$	$1 \times 10^3$

CLASSIFICATION OF MATERIAL

**Low specific activity material**

408. *Radioactive material* may only be classified as *LSA material* if the conditions of paras 226, 409–411 and 517–522 are met.

409. *LSA material* shall be in one of three groups:

(a) *LSA-I*:

- (i) *Uranium* and *thorium* ores and concentrates of such ores, and other ores containing naturally occurring radionuclides.

- (ii) *Natural uranium, depleted uranium*, natural thorium or their compounds or mixtures, that are unirradiated and in solid or liquid form.
- (iii) *Radioactive material* for which the  $A_2$  value is unlimited. *Fissile material* may be included only if excepted under para. 417.
- (iv) Other *radioactive material* in which the activity is distributed throughout and the estimated average *specific activity* does not exceed 30 times the values for the activity concentration specified in paras 402–407. *Fissile material* may be included only if excepted under para. 417.

(b) LSA-II:

- (i) Water with a tritium concentration of up to 0.8 TBq/L;
- (ii) Other material in which the activity is distributed throughout and the estimated average *specific activity* does not exceed  $10^{-4} A_2/g$  for solids and gases, and  $10^{-5} A_2/g$  for liquids.

(c) LSA-III:

Solids (e.g. consolidated wastes, activated materials), excluding powders, ~~that meet the requirements of para. 601,~~ in which:

- (i) The *radioactive material* is distributed throughout a solid or a collection of solid objects, or is essentially uniformly distributed in a solid compact binding agent (such as concrete, bitumen and ceramic).
- (ii) ~~The radioactive material is relatively insoluble, or is intrinsically contained in a relatively insoluble matrix, so that, even under loss of packaging, the loss of radioactive material per package by leaching when placed in water for 7 days would not exceed  $0.1A_2$ .~~
- (iii) The estimated average specific activity of the solid, excluding any shielding material, does not exceed  $2 \times 10^{-3}A_2/g$ .

410. A single *package* of non-combustible solid LSA-II or LSA-III material, if carried by air, shall not contain an activity greater than  $3000 A_2$ .

411. The *radioactive contents* in a single *package* of LSA material shall be so restricted that the ~~radiation level~~ dose equivalent rate specified in para. 517 shall not be exceeded, and the activity in a single *package* shall also be so restricted that the activity limits for a *conveyance* specified in para. 522 shall not be exceeded.

**Surface contaminated object**

412. *Radioactive material* may be classified as *SCO* if the conditions in paras 241, 413, 414 and 517– 522 are met.

413. *SCO* shall be in one of ~~two~~three groups:

(a) *SCO-I*: A solid object on which:

- (i) The *non-fixed contamination* on the accessible surface averaged over 300 cm<sup>2</sup> (or the area of the surface if less than 300 cm<sup>2</sup>) does not exceed 4 Bq/cm<sup>2</sup> for beta and gamma emitters and *low toxicity alpha emitters*, or 0.4 Bq/cm<sup>2</sup> for all other alpha emitters.
- (ii) The *fixed contamination* on the accessible surface averaged over 300 cm<sup>2</sup> (or the area of the surface if less than 300 cm<sup>2</sup>) does not exceed  $4 \times 10^4$  Bq/cm<sup>2</sup> for beta and gamma emitters and *low toxicity alpha emitters*, or 4000 Bq/cm<sup>2</sup> for all other alpha emitters.
- (iii) The *non-fixed contamination* plus the *fixed contamination* on the inaccessible surface averaged over 300 cm<sup>2</sup> (or the area of the surface if less than 300 cm<sup>2</sup>) does not exceed  $4 \times 10^4$  Bq/cm<sup>2</sup> for beta and gamma emitters and *low toxicity alpha emitters*, or 4000 Bq/cm<sup>2</sup> for all other alpha emitters.

(b) *SCO-II*: A solid object on which either the *fixed* or *non-fixed contamination* on the surface exceeds the applicable limits specified for *SCO-I* in (a) above and on which:

- (i) The *non-fixed contamination* on the accessible surface averaged over 300 cm<sup>2</sup> (or the area of the surface if less than 300 cm<sup>2</sup>) does not exceed 400 Bq/cm<sup>2</sup> for beta and gamma emitters and *low toxicity alpha emitters*, or 40 Bq/cm<sup>2</sup> for all other alpha emitters.
- (ii) The *fixed contamination* on the accessible surface averaged over 300 cm<sup>2</sup> (or the area of the surface if less than 300 cm<sup>2</sup>) does not exceed  $8 \times 10^5$  Bq/cm<sup>2</sup> for beta and gamma emitters and *low toxicity alpha emitters*, or  $8 \times 10^4$  Bq/cm<sup>2</sup> for all other alpha emitters.
- (iii) The *non-fixed contamination* plus the *fixed contamination* on the inaccessible surface averaged over 300 cm<sup>2</sup> (or the area of the surface if less than 300 cm<sup>2</sup>) does not exceed  $8 \times 10^5$  Bq/cm<sup>2</sup> for beta and gamma emitters and *low toxicity alpha emitters*, or  $8 \times 10^4$  Bq/cm<sup>2</sup> for all other alpha emitters.

(c) *SCO-III*: A large solid object which because of its size cannot be transported in a type of package described in these Regulations and for which:

(i) All openings are sealed to prevent release of radioactive material during routine conditions of transport;

(ii) The inside of the object is as dry as practicable;

(iii) The non-fixed contamination on the external surfaces does not exceed the limits specified in para. 508;

(iv) The non-fixed contamination plus the fixed contamination on the inaccessible surface averaged over 300 cm<sup>2</sup> does not exceed  $8 \times 10^5$  Bq/cm<sup>2</sup> for beta and gamma emitters and low toxicity alpha emitters, or  $8 \times 10^4$  Bq/cm<sup>2</sup> for all other alpha emitters, unless it can be demonstrated that, following a transport accident, the activity intake by a person in the vicinity of the accident does not exceed  $10^{-6}A_2$  or a corresponding inhalation dose of 50 mSv.

414. The *radioactive contents* in a single *package* of *SCO* shall be so restricted that the ~~radiation level~~*dose equivalent rate* specified in para. 517 shall not be exceeded, and the activity in a single *package* shall also be so restricted that the activity limits for a *conveyance* specified in para. 522 shall not be exceeded.

### **Special form radioactive material**

415. *Radioactive material* may be classified as *special form radioactive material* only if it meets the requirements of paras 602–604 and 802.

### **Low dispersible radioactive material**

416. *Radioactive material* may be classified as *low dispersible radioactive material* only if it meets the requirements of para. 605, taking into account the requirements of paras 665 and 802.

### **Fissile material**

417. *Fissile material* and *packages* containing *fissile material* shall be classified under the relevant entry as “FISSILE”, in accordance with Table 1 unless excepted by one of the provisions of subparagraphs (a)–(f) of this paragraph and transported subject to the requirements of para. 570. All provisions apply only to material in *packages* that meet the requirements of para. 636, unless unpackaged material is specifically allowed in the provision:

(a) *Uranium* enriched in uranium-235 to a maximum of 1% by mass, and with a total plutonium and uranium-233 content not exceeding 1% of the mass of uranium-235, provided that the *fissile nuclides* are distributed essentially homogeneously

throughout the material. In addition, if uranium-235 is present in metallic, oxide or carbide forms, it shall not form a lattice arrangement.

- (b) Liquid solutions of uranyl nitrate enriched in uranium-235 to a maximum of 2% by mass, with a total plutonium and uranium-233 content not exceeding 0.002% of the mass of *uranium*, and with a minimum nitrogen to *uranium* atomic ratio (N/U) of 2.
- (c) *Uranium* with a maximum *uranium* enrichment of 5% by mass of uranium- 235 provided:
  - (i) There is no more than 3.5 g of uranium-235 per *package*.
  - (ii) The total plutonium and uranium-233 content does not exceed 1% of the mass of uranium-235 per *package*.
  - (iii) Transport of the *package* is subject to the *consignment* limit provided in para. 570(c).
- (d) *Fissile nuclides* with a total mass not greater than 2.0 g per *package*, provided the *package* is transported subject to the *consignment* limit provided in para. 570(d).
- (e) *Fissile nuclides* with a total mass not greater than 45 g, either packaged or unpackaged, subject to the ~~limits provided in requirements of~~ para. 570(e). (f) A *fissile material* that meets the requirements of paras 570(b), 606 and 802.

418. The contents of *packages* containing *fissile material* shall be as specified for the *package design*, either directly in these Regulations or in the certificate of *approval*.

### **Uranium hexafluoride**

419. Uranium hexafluoride shall be assigned to one of the following UN numbers only:

- (a) UN 2977, RADIOACTIVE MATERIAL, URANIUM HEXAFLUORIDE, FISSILE;
- (b) UN 2978, RADIOACTIVE MATERIAL, URANIUM HEXAFLUORIDE, non-fissile or fissile-excepted;
- (c) UN 3507, URANIUM HEXAFLUORIDE, RADIOACTIVE MATERIAL, EXCEPTED PACKAGE, less than 0.1 kg per package, non-fissile or fissile-excepted.

420. The contents of a *package* containing uranium hexafluoride shall comply with the following requirements:

- (a) The mass of uranium hexafluoride shall not be different from that allowed for the *package design*.

- (b) The mass of uranium hexafluoride shall not be greater than a value that would lead to an ullage of less than 5% at the maximum temperature of the package, as specified for the plant systems where the *package* might be used.
- (c) The uranium hexafluoride shall be in solid form and the internal pressure shall not be above atmospheric pressure when presented for transport.

**CLASSIFICATION OF PACKAGES**

421. The quantity of *radioactive material* in a *package* shall not exceed the relevant limits for the *package Type As* specified below.

**Classification as excepted package**

422. A *package* may be classified as an excepted *package* if it meets one of the following conditions:

- (a) It is an empty *package* having contained *radioactive material*;
- (b) It contains instruments or articles not exceeding the activity limits specified in Table 4;
- (c) It contains articles manufactured of *natural uranium, depleted uranium* or natural thorium;
- (d) It contains *radioactive material* not exceeding the activity limits specified in Table 4;
- (e) It contains less than 0.1 kg of uranium hexafluoride not exceeding the activity limits specified in column 4 of Table 4.

**TABLE 4. ACTIVITY LIMITS FOR EXCEPTED PACKAGES**

Physical state of contents	Instrument or article		Materials
	Item limits <sup>a</sup>	<i>Package</i> limits <sup>b</sup>	<i>Package</i> limits <sup>b</sup>
Solids			
<i>Special form</i>	$10^{-2}A_1$	$A_1$	$10^{-3}A_1$
Other forms	$10^{-2}A_2$	$A_2$	$10^{-3}A_2$
Liquids	$10^{-3}A_2$	$10^{-1}A_2$	$10^{-4}A_2$
Gases			

Tritium	$2 \times 10^{-2}A_2$	$2 \times 10^{-1}A_2$	$2 \times 10^{-2}A_2$
<i>Special form</i>	$10^{-3}A_1$	$10^{-2}A_1$	$10^{-3}A_1$
Other forms	$10^{-3}A_2$	$10^{-2}A_2$	$10^{-3}A_2$

<sup>a</sup> For mixtures of radionuclides, see paras 405-407.

423. *Radioactive material* that is enclosed in or is included as a component part of an instrument or other manufactured article, may be classified under UN 2911, RADIOACTIVE MATERIAL, EXCEPTED PACKAGE — INSTRUMENTS or ARTICLES, provided that:

- (a) The ~~radiation level~~*dose equivalent rate* at 10 cm from any point on the external surface of any unpackaged instrument or article is not greater than 0.1 mSv/h.
- (b) Each instrument or article bears the marking “RADIOACTIVE” on its external surface except for the following:
  - (i) Radioluminescent timepieces or devices do not require markings.
  - (ii) Consumer products that have either received regulatory *approval* in accordance with para. 107(e) or do not individually exceed the activity limit for an exempt *consignment* in Table 2 (column 5) do not require markings, provided that such products are transported in a *package* that bears the marking “RADIOACTIVE” on its internal surface in such a manner that a warning of the presence of *radioactive material* is visible on opening the *package*.
  - (iii) Other instruments or articles too small to bear the marking “RADIOACTIVE” do not require markings, provided that they are transported in a *package* that bears the marking “RADIOACTIVE” on its internal surface in such a manner that a warning of the presence of *radioactive material* is visible on opening the *package*.
- (c) The active material is completely enclosed by non-active components (a device performing the sole function of containing *radioactive material* shall not be considered to be an instrument or manufactured article).
- (d) The limits specified in columns 2 and 3 of Table 4 are met for each individual item and each *package*, respectively.
- (e) For transport by post, the total activity in each *excepted package* shall not exceed one tenth of the relevant limits specified in column 3 of Table 4.

(f) If the package contains fissile material, one of the provisions of para. 417 shall apply.

424. *Radioactive material* in forms other than as specified in para. 423 and with an activity not exceeding the limits specified in column 4 of Table 4 may be classified under UN 2910, RADIOACTIVE MATERIAL, EXCEPTED PACKAGE — LIMITED QUANTITY OF MATERIAL, provided that:

- (a) The *package* retains its *radioactive contents* under routine conditions of transport.
- (b) The *package* bears the marking “RADIOACTIVE” on either:
  - (i) An internal surface in such a manner that a warning of the presence of *radioactive material* is visible on opening the *package*; or
  - (ii) The outside of the *package*, where it is impractical to mark an internal surface.
- (c) For transport by post, the total activity in each *excepted package* shall not exceed one tenth of the relevant limits specified in column 4 of Table 4.

(d) If the package contains fissile material, one of the provisions of para. 417 shall apply.

425. Uranium hexafluoride not exceeding the limits specified in column 4 of Table 4 may be classified under UN 3507 URANIUM HEXAFLUORIDE, RADIOACTIVE MATERIAL, EXCEPTED PACKAGE, less than 0.1 kg per *package*, non-fissile or fissile-excepted, provided that:

- (a) The mass of uranium hexafluoride in the *package* is less than 0.1 kg.
- (b) The conditions of paras 420, 424(a) and 424(b) are met.

426. Articles manufactured of *natural uranium*, *depleted uranium* or natural thorium and articles in which the sole *radioactive material* is unirradiated natural uranium, unirradiated depleted uranium or unirradiated natural thorium may be classified under UN 2909, RADIOACTIVE MATERIAL, EXCEPTED PACKAGE — ARTICLES MANUFACTURED FROM NATURAL URANIUM or DEPLETED URANIUM or NATURAL THORIUM, provided that the outer surface of the uranium or thorium is enclosed in an inactive sheath made of metal or some other substantial material.

**Additional requirements and controls for transport of empty packagings**

427. An empty *packaging* that had previously contained *radioactive material* may be classified under UN 2908, RADIOACTIVE MATERIAL, EXCEPTED PACKAGE — EMPTY PACKAGING, provided that:

- (a) It is in a well-maintained condition and securely closed.
- (b) The outer surface of any *uranium* or *thorium* in its structure is covered with an inactive sheath made of metal or some other substantial material.
- (c) The level of internal *non-fixed contamination* does not exceed 100 times the levels specified in para. 508.
- (d) Any labels that may have been displayed on it in conformity with para. 538 are no longer visible.

(e) If the *packaging has contained fissile material*, one of the provisions of para. 417 shall apply.

### **Classification as Type A package**

428. *Packages* containing *radioactive material* may be classified as *Type A packages* provided that the conditions of paras 429 and 430 are met.

429. *Type A packages* shall not contain activities greater than either of the following:

- (a) For *special form radioactive material* —  $A_1$ ;
- (b) For all other *radioactive material* —  $A_2$ .

430. For mixtures of radionuclides whose identities and respective activities are known, the following condition shall apply to the *radioactive contents* of a *Type A package*:

$$\sum_i \frac{B(i)}{A_1(i)} + \sum_j \frac{C(j)}{A_2(j)}$$

where

$B(i)$  is the activity of radionuclide  $i$  as *special form radioactive material*;

$A_1(i)$  is the  $A_1$  value for radionuclide  $i$ ;

$C(j)$  is the activity of radionuclide  $j$  as other than *special form radioactive material*;

$A_2(j)$  is the  $A_2$  value for radionuclide  $j$ .

### **Classification as Type B(U), Type B(M) or Type C package**

431. *Type B(U)*, *Type B(M)* and *Type C packages* shall be classified in accordance with the *competent authority* certificate of approval for the *package design* issued by the country of origin of *design*.

432. The contents of a *Type B(U)*, *Type B(M)* or *Type C package* shall be as specified in the certificate of *approval*.

433. *Type B(U)* and *Type B(M) packages*, if transported by air, shall meet the requirements of para. 432 and shall not contain activities greater than the following:

- (a) For low dispersible *radioactive material* — as authorized for the *package design* as specified in the certificate of *approval*;
- (b) For *special form radioactive material* —  $3000 A_1$  or  $10^5 A_2$ , whichever is the lower;
- (c) For all other *radioactive material* —  $3000 A_2$ .

#### SPECIAL ARRANGEMENT

434. *Radioactive material* shall be classified as transported under *special arrangement* when it is intended to be carried in accordance with para. 310.

## Section V

### REQUIREMENTS AND CONTROLS FOR TRANSPORT

#### REQUIREMENTS BEFORE THE FIRST SHIPMENT

501. Before a *packaging* is first used to transport *radioactive material*, it shall be confirmed that it has been manufactured in conformity with the *design* specifications to ensure compliance with the relevant provisions of these Regulations and any applicable certificate of *approval*. The following requirements shall also be fulfilled, if applicable:

- (a) If the *design* pressure of the *containment system* exceeds 35 kPa (gauge), it shall be ensured that the *containment system* of each *packaging* conforms to the approved *design* requirements relating to the capability of that system to maintain its integrity under that pressure.
- (b) For each *packaging* intended for use as a *Type B(U)*, *Type B(M)* or *Type C package* and for each *packaging* intended to contain *fissile material*, it shall be ensured that the effectiveness of its shielding and containment and, where necessary, the heat transfer characteristics and the effectiveness of the *confinement system*, are within the limits applicable to or specified for the approved *design*.
- (c) For each *packaging* intended to contain *fissile material*, it shall be ensured that the effectiveness of the criticality safety features is within the limits applicable to or specified for the *design*, and in particular where, in order to comply with the requirements of para. 673, neutron poisons are specifically included, checks shall be performed to confirm the presence and distribution of those neutron poisons.

#### REQUIREMENTS BEFORE EACH SHIPMENT

502. Before each *shipment* of any *package*, it shall be ensured that the *package* contains neither:

- (a) Radionuclides different from those specified for the *package design*; nor
- (b) Contents in a form, or physical or chemical state, different from those specified for the *package design*.

503. Before each *shipment* of any *package*, it shall be ensured that all the requirements specified in the relevant provisions of these Regulations and in the applicable certificates of *approval* have been fulfilled. The following requirements shall also be fulfilled, if applicable:

- (a) It shall be ensured that lifting attachments that do not meet the requirements of para. 608 have been removed or otherwise rendered incapable of being used for lifting the *package*, in accordance with para. 609.
- (b) Each *Type B(U)*, *Type B(M)* and *Type C package* shall be held until equilibrium conditions have been approached closely enough to demonstrate compliance with the requirements for temperature and pressure, unless an exemption from these requirements has received *unilateral approval*.
- (c) For each *Type B(U)*, *Type B(M)* and *Type C package*, it shall be ensured by inspection and/or appropriate tests that all closures, valve and other openings of the *containment system* through which the *radioactive contents* might escape are properly closed and, where appropriate, sealed in the manner for which the demonstrations of compliance with the requirements of paras 659 and 671 were made.
- (d) For *packages* containing *fissile material*, the measurement specified in para. 677(b) and the tests to demonstrate closure of each *package* as specified in para. 680 shall be performed.
- (e) For packages intended to be used for shipment after storage, it shall be ensured that all packaging components and radioactive contents have been maintained during storage in a manner such that all the requirements specified in the relevant provisions of these Regulations and in the applicable certificates of approval have been fulfilled.

## TRANSPORT OF OTHER GOODS

504. A *package* shall not contain any items other than those that are necessary for the use of the *radioactive material*. The interaction between these items and the *package*, under the conditions of transport applicable to the *design*, shall not reduce the safety of the *package*.

505. *Freight containers, IBCs, tanks*, as well as other *packagings* and *overpacks*, used for the transport of *radioactive material* shall not be used for the storage or transport of other goods unless decontaminated below the level of 0.4 Bq/cm<sup>2</sup> for beta and gamma emitters and low toxicity alpha emitters and 0.04 Bq/cm<sup>2</sup> for all other alpha emitters.

506. *Consignments* shall be segregated from other dangerous goods during transport in compliance with the relevant transport regulations for dangerous goods of each of the countries *through or into* which the materials will be transported, and, where applicable, with the regulations of the cognizant transport organizations, as well as these Regulations.

## OTHER DANGEROUS PROPERTIES OF CONTENTS

507. In addition to the radioactive and fissile properties, any other dangerous properties of the contents of the *package*, such as explosiveness, flammability, pyrophoricity, chemical toxicity and corrosiveness, shall be taken into account in the packing, labelling, marking, placarding, storage and transport in order to be in compliance with the relevant transport regulations for dangerous goods of each of the countries *through or into* which the materials will be transported, and, where applicable, with the regulations of the cognizant transport organizations, as well as these Regulations.

## REQUIREMENTS AND CONTROLS FOR CONTAMINATION AND FOR LEAKING PACKAGES

508. The *non-fixed contamination* on the external surfaces of any *package* shall be kept as low as practicable and, under routine conditions of transport, shall not exceed the following limits:

(a)  $4 \text{ Bq/cm}^2$  for beta and gamma emitters and *low toxicity alpha emitters*;

(b)  $0.4 \text{ Bq/cm}^2$  for all other alpha emitters.

These limits are applicable when averaged over any area of  $300 \text{ cm}^2$  of any part of the surface.

509. Except as provided in para. 514, the level of *non-fixed contamination* on the external and internal surfaces of *overpacks*, *freight containers*, ~~tanks~~, ~~IBCs~~ and *conveyances* shall not exceed the limits specified in para. 508. This requirement does not apply to freight containers used as packagings, either loaded or empty.

510. If it is evident that a *package* is damaged or leaking, or if it is suspected that the package may have leaked or been damaged, access to the *package* shall be restricted and a qualified person shall, as soon as possible, assess the extent of contamination and the resultant ~~radiation level~~ *dose equivalent rate* of the *package*. The scope of the assessment shall include the *package*, the *conveyance*, the adjacent loading and unloading areas and, if necessary, all other material that has been carried in the conveyance. When necessary, additional steps for the protection of persons, property and the environment, in accordance with provisions established by the relevant *competent authority*, shall be taken to overcome and minimize the consequences of such leakage or damage.

511. *Packages* that are damaged or leaking *radioactive contents* in excess of allowable limits for normal conditions of transport may be removed to an acceptable interim location under supervision, but shall not be forwarded until repaired or reconditioned and decontaminated.

512. A *conveyance* and equipment used regularly for the transport of *radioactive material* shall be periodically checked to determine the level of *contamination*. The frequency of such checks shall be related to the likelihood of *contamination* and the extent to which *radioactive material* is transported.

513. Except as provided in para. 514, any *conveyance*, or equipment or part thereof that has become contaminated above the limits specified in para. 508 in the course of the transport of *radioactive material*, or that shows a ~~radiation level~~dose equivalent rate in excess of 5  $\mu\text{Sv/h}$  at the surface, shall be decontaminated as soon as possible by a qualified person and shall not be reused unless the following conditions are fulfilled:

- (a) The *non-fixed contamination* shall not exceed the limits specified in para. 508.
- (b) The ~~radiation level~~dose equivalent rate resulting from the *fixed contamination* shall not exceed 5  $\mu\text{Sv/h}$  at the surface.

514. A *freight container*, ~~tank~~, ~~IBC~~ or *conveyance* dedicated to the transport of unpackaged *radioactive material* under exclusive use shall be excepted from the requirements of paras 509 and 513 solely with regard to its internal surfaces and only for as long as it remains under that specific exclusive use.

#### REQUIREMENTS AND CONTROLS FOR TRANSPORT OF EXCEPTED PACKAGES

515. *Excepted packages* shall be subject only to the following provisions in Sections V and VI:

- (a) ~~The requirements specified in paras 503–505, 507–513, 516, 530–533, 545, 546 introductory sentence, 546(a), 546 (j)(i) and (ii) 546(k), 546 (m), 550–553, 555, 556, 561, 564, 570, 582 and 583; The requirements specified in paras 503–505, 507–513, 516, 530–533, 545, 546 introductory sentence, 546(a), 546(k), 550–553, 555, 556, 561, 564, 582 and 583;~~
- (b) The requirements for *excepted packages* specified in para. 622;
- (c) The requirements specified in paras 580 and 581, if transported by post.

All relevant provisions of the other sections shall apply to *excepted packages*. ~~If the excepted package contains fissile material, one of the fissile exceptions provided by para. 417 shall apply.~~

516. The ~~radiation level~~dose equivalent rate at any point on the external surface of an *excepted package* shall not exceed 5  $\mu\text{Sv/h}$ .

## REQUIREMENTS AND CONTROLS FOR TRANSPORT OF LSA MATERIAL AND SCO IN INDUSTRIAL PACKAGES OR UNPACKAGED

517. The quantity of *LSA material* or *SCO* in a single *Type IP-1*, *Type IP-2*, *Type IP-3* package, ~~SCO-III~~, or object or collection of objects, whichever is appropriate, shall be so restricted that the external ~~radiation level~~ *dose equivalent rate* at 3 m from the unshielded material or object or collection of objects does not exceed 10 mSv/h.

518. For *LSA material* and *SCO* that are or contain *fissile material*, that is not excepted under para. 417, the applicable requirements of paras 568 and 569 shall be met.

519. For *LSA material* and *SCO* that are or contain *fissile material*, the applicable requirements of para. 673 shall be met.

520. *LSA material* and *SCO* in groups *LSA-I*, *SCO-I* and *SCO-III* may be transported, unpackaged, under the following conditions:

- (a) All unpackaged material other than ores containing only naturally occurring radionuclides shall be transported in such a manner that under routine conditions of transport there will be no escape of the *radioactive contents* from the *conveyance* nor will there be any loss of shielding.
- (b) Each *conveyance* shall be under *exclusive use*, except when only transporting *SCO-I* on which the *contamination* on the accessible and the inaccessible surfaces is not greater than 10 times the applicable level specified in para. 214.
- (c) For *SCO-I* where it is suspected that *non-fixed contamination* exists on inaccessible surfaces in excess of the values specified in para. 413(a)(i), measures shall be taken to ensure that the *radioactive material* is not released into the *conveyance*.
- (d) Unpackaged *fissile material* shall meet the requirement of para. 417(e).

(e) For *SCO-III*:

(i) Transport shall be under *exclusive use* by road, rail or vessel;

(ii) Stacking shall not be permitted;

(iii) The requirements of para. 624 for a *Type IP-2* package shall be satisfied, except that the maximum damage referred to in para. 722 may be determined based on provisions in the transport plan (para. 827 bis.(f)), and the requirements of para. 723 are not applicable.

(iv) The object and any shielding are secured to the *conveyance* in accordance with para. 607.

(v) The transport shall be subject to multilateral approval.

521. *LSA material* and *SCO*, except as otherwise specified in para. 520, shall be packaged in accordance with Table 5.

522. The total activity in a single hold or compartment of an inland waterway craft, or in another *conveyance*, for carriage of *LSA material* or *SCO* in a *Type IP-1*, *Type IP-2*, *Type IP-3 package* or unpackaged, shall not exceed the limits shown in Table 6. For *SCO-III*, the limits in Table 6 may be exceeded provided it can be demonstrated that, following a transport accident, the activity intake by a person in the vicinity of the accident does not exceed  $10^{-6}A_2$  or a corresponding inhalation dose of 50 mSv.

#### DETERMINATION OF TRANSPORT INDEX

523. The *TI* for a *package*, *overpack* or *freight container*, or for unpackaged *LSA-I*, ~~*or SCO-I*~~ *or SCO-III*, shall be the number derived in accordance with the following procedure:

(a) Determine the maximum ~~radiation level~~ dose equivalent rate in units of millisieverts per hour (mSv/h) at a distance of 1 m from the external surfaces of the *package*, *overpack*, *freight container* or unpackaged *LSA-I*, ~~and *SCO-I* and *SCO-III*~~. The value determined shall be multiplied by 100 and the resulting number is the *TI*. For *uranium* and thorium ores and their concentrates, the maximum ~~radiation level~~ dose equivalent rate at any point 1 m from the external surface of the load may be taken as:

(i) 0.4 mSv/h for ores and physical concentrates of *uranium* and thorium;

(ii) 0.3 mSv/h for chemical concentrates of thorium;

(iii) 0.02 mSv/h for chemical concentrates of *uranium*, other than uranium hexafluoride.

(b) For tanks, freight containers and unpackaged *LSA-I*, ~~and *SCO-I* and *SCO-III*~~, the value determined in step (a) shall be multiplied by the appropriate factor from Table 7.

(c) The value obtained in steps (a) and (b) shall be rounded up to the first decimal place (for example, 1.13 becomes 1.2), except that a value of 0.05 or less may be considered as zero.

TABLE 5. INDUSTRIAL PACKAGE REQUIREMENTS FOR LSA MATERIAL AND SCO

<i>Radioactive contents</i>	<i>Industrial package type</i>	
	<i>Exclusive use</i>	<i>Not under exclusive use</i>
<i>LSA-I</i>		
Solid <sup>a</sup>	<i>Type IP-1</i>	<i>Type IP-1</i>
Liquid	<i>Type IP-1</i>	<i>Type IP-2</i>
<i>LSA-II</i>		
Solid	<i>Type IP-2</i>	<i>Type IP-2</i>
Liquid and gas	<i>Type IP-2</i>	<i>Type IP-3</i>
<i>LSA-III</i>		
	<i>Type IP-2</i>	<i>Type IP-3</i>
<i>SCO-I<sup>a</sup></i>		
	<i>Type IP-1</i>	<i>Type IP-1</i>
<i>SCO-II</i>		
	<i>Type IP-2</i>	<i>Type IP-2</i>

<sup>a</sup> Under the conditions specified in para. 520, *LSA-I material* and *SCO-I* may be transported unpackaged.

TABLE 6. CONVEYANCE ACTIVITY LIMITS FOR LSA MATERIAL AND SCO IN INDUSTRIAL PACKAGES OR UNPACKAGED

Nature of material	Activity limit for conveyances other than inland waterway craft	Activity limit for a hold or compartment of
<i>LSA-I</i>	No limit	No limit
<i>LSA-II and LSA-III non-combustible</i>	No limit	100 A2
<i>LSA-II and LSA-III combustible solids and all liquids and gases</i>	100 A2	10 A2
<i>SCO<sup>1</sup></i>	100 A2	10 A2

<sup>1</sup> For *SCO-III* see para. 522

524. ~~The TI for each overpack, freight container or conveyance shall be determined by the consignor as either the sum of the TIs of all the packages contained, or by direct measurement of radiation leveldose equivalent, except in the case of non rigid~~

~~overpacks, for which the TI shall be determined only as the sum of the TIs of all the packages.~~

The TI for each rigid overpack, freight container or conveyance shall be determined as the sum of the TIs of all the packages. For a shipment from a single consignor, the consignor may determine the TI by direct measurement of dose equivalent rate.

524bis. The TI for a non-rigid overpack shall be determined only as the sum of the TIs of all the packages

#### DETERMINATION OF CRITICALITY SAFETY INDEX FOR CONSIGNMENTS, FREIGHT CONTAINERS AND OVERPACKS

525. The CSI for each overpack or freight container shall be determined as the sum of the CSIs of all the packages contained. The same procedure shall be followed for determining the total sum of the CSIs in a consignment or aboard a conveyance.

TABLE 7. MULTIPLICATION FACTORS FOR TANKS, FREIGHT CONTAINERS AND UNPACKAGED LSA-I; AND SCO-I ~~AND SCO-III~~

Size of load <sup>a</sup>	Multiplication factor
size of load $\leq 1 \text{ m}^2$	1
$1 \text{ m}^2 < \text{size of load} \leq 5 \text{ m}^2$	2
$5 \text{ m}^2 < \text{size of load} \leq 20 \text{ m}^2$	3
$20 \text{ m}^2 < \text{size of load}$	10

a Largest cross-sectional area of the load being measured.

#### LIMITS ON TRANSPORT INDEX, CRITICALITY SAFETY INDEX AND ~~RADIATION LEVEL~~ DOSE EQUIVALENT RATES FOR PACKAGES AND OVERPACKS

526. Except for consignments under exclusive use, the TI of any package or overpack shall not exceed 10, nor shall the CSI of any package or overpack exceed 50.

527. Except for packages or overpacks transported under exclusive use by rail or by road under the conditions specified in para. 573(a), or under exclusive use and special arrangement by vessel or by air under the conditions specified in para. 575 or para. 579, respectively, the maximum ~~radiation level~~ dose equivalent rate at any point on the external surface of a package or overpack shall not exceed 2 mSv/h.

528. The maximum ~~radiation level~~ dose equivalent rate at any point on the external surface of a package or overpack under exclusive use shall not exceed 10 mSv/h.

#### CATEGORIES

529. *Packages, overpacks and freight containers* shall be assigned to either category I-WHITE, II-YELLOW or III-YELLOW in accordance with the conditions specified in Table 8 and with the following requirements:

TABLE 8. CATEGORIES OF PACKAGES, OVERPACKS AND FREIGHT CONTAINERS

Conditions		Category
<i>TI</i>	Maximum <i>radiation level</i> at any point on external surface	
0 <sup>a</sup>	Not more than 0.005 mSv/h	I-WHITE
More than 0 but not more than 1 <sup>a</sup>	More than 0.005 mSv/h but not more than 0.5 mSv/h	II-Yellow
More than 1 but not more than 10	More than 0.5 mSv/h but not more than 2 mSv/h	III-YELLOW
More than 10	More than 2 mSv/h but not more than 10 mSv/h	III-YELLOW <sup>b</sup>

<sup>a</sup> If the measured *TI* is not greater than 0.05, the value quoted may be zero in accordance with para. 523(c).

<sup>b</sup> Shall also be transported under *exclusive use* except for *freight containers* (see Table 10).

- (a) For a *package, overpack or freight container*, the *TI* and the surface ~~radiation level~~dose equivalent rate conditions shall be taken into account in determining which category is appropriate. Where the *TI* satisfies the condition for one category but the surface ~~radiation level~~dose equivalent rate satisfies the condition for a different category, the *package, overpack or freight container* shall be assigned to the higher category. For this purpose, category I-WHITE shall be regarded as the lowest category.
- (b) The *TI* shall be determined following the procedures specified in paras 523 and 524.
- (c) If the surface ~~radiation level~~dose equivalent rate is greater than 2 mSv/h, the *package or overpack* shall be transported under *exclusive use* and under the provisions of paras 573(a), 575 or 579, as appropriate.
- (d) A *package* transported under a *special arrangement* shall be assigned to category III-YELLOW except under the provisions of para. 530.
- (e) An *overpack or freight container* that contains *packages* transported under special arrangement shall be assigned to category III-YELLOW except under the provisions of para. 530.

MARKING, LABELLING AND PLACARDING

530. For each *package* or *overpack*, the UN number and proper shipping name shall be determined (see Table 1). In all cases of international transport of *packages* requiring *competent authority approval of design* or *Shipment*, for which different *approval* types apply in the different countries concerned by the *shipment*, the UN number, proper shipping name, categorization, labelling and marking shall be in accordance with the certificate of the country of origin of *design*.

## Marking

531. Each *package* shall be legibly and durably marked on the outside of the *packaging* with an identification of either the *consignor* or *consignee*, or both. Each *overpack* shall be legibly and durably marked on the outside of the *overpack* with an identification of either the *consignor* or *consignee*, or both, unless these markings of all the *packages* within the *overpack* are clearly visible.

532. Each *package* shall be legibly and durably marked on the outside with the UN marking as specified in Table 9. Additionally, each *overpack* shall be legibly and durably marked with the word “OVERPACK” and the UN marking as specified in Table 9 unless all the markings of the *packages* within the *overpack* are clearly visible.

533. Each *package* of gross mass exceeding 50 kg shall have its permissible gross mass legibly and durably marked on the outside of the *packaging*.

534. Each *package* that conforms to:

- (a) An *IP-1*, *IP-2* or *IP-3 design* shall be legibly and durably marked on the outside of the *packaging* with “TYPE IP-1”, “TYPE IP-2” or “TYPE IP-3”, as appropriate.
- (b) A *Type A package design* shall be legibly and durably marked on the outside of the *packaging* with “TYPE A”.
- (c) An *IP-2*, *IP-3* or a *Type A package design* shall be legibly and durably marked on the outside of the *packaging* with the international vehicle registration code (VRI code) of the country of origin of *design* and either the name of the manufacturer or other identification of the *packaging* specified by the *competent authority* of the country of origin of *design*.

~~Any markings “TYPE IP 1”, “TYPE IP 2”, “TYPE IP 3”, “TYPE IP 3” or “TYPE A” that do not relate to the assigned UN number shall be removed or covered.~~

TABLE 9. UN MARKING FOR *PACKAGES* AND *OVERPACKS*

Item	UN marking <sup>a</sup>
<i>Package</i> (other than an <i>excepted package</i> )	UN number, preceded by the letters “UN”, and the proper shipping name
<i>Excepted package</i> (other than those in <i>consignments</i> accepted for international movement by post)	UN number, preceded by the letters “UN”
<i>Overpack</i> (other than an <i>Overpack</i> containing only <i>excepted packages</i> )	UN number, preceded by the letters “UN” for each applicable UN number in the <i>Overpack</i> , followed by the proper shipping name in the case of a <i>non-excepted package</i>
<i>Overpack</i> containing only <i>excepted packages</i> (other than <i>consignments</i> accepted for international movement by post)	UN number, preceded by the letters “UN” for each applicable UN number in the <i>Overpack</i>
<i>Consignment</i> accepted for international movement by post	The requirement of para. 581

<sup>a</sup> See Table 1 for listing of UN numbers and proper shipping names.

535. Each *package* that conforms to a *design* approved under one or more of paras 807–816 and 820 shall be legibly and durably marked on the outside of the *packaging* with the following information:

- (a) The identification mark allocated to that *design* by the *competent authority*;
- (b) A serial number to identify uniquely each *packaging* that conforms to that *design*;
- (c) “TYPE B(U)”, “TYPE B(M)” or “TYPE C”, in the case of a *Type B(U)*, *Type B(M)* or *Type C package design*.

~~Any markings “TYPE B(U)”, “TYPE B(M)”, “TYPE C” that do not relate to the assigned UN number shall be removed or covered.~~

536. Each *package* that conforms to a *Type B(U)*, *Type B(M)* or *Type C package design* shall have the outside of the outermost receptacle, that is resistant to the effects of fire and water, plainly marked by embossing, stamping or other means resistant to the effects of fire and water with the trefoil symbol shown in Fig. 1.

~~Any markings “TYPE B(U)”, “TYPE B(M)”, “TYPE C” that do not relate to the assigned UN number shall be removed or covered.~~

536bis. Any marking on the package that does not relate to the shipment shall be removed or covered.

537. Where *LSA-I* or *SCO-I* material is contained in receptacles or wrapping materials and is transported under *exclusive use*, as permitted by para. 520, the outer surface of these receptacles or wrapping materials may bear the marking “RADIOACTIVE LSA-I” or “RADIOACTIVE SCO-I”, as appropriate.

### Labelling

538. Each *package*, *overpack* and *freight container* shall bear the labels conforming to the applicable models in Figs 2–4, except as allowed under the alternative provisions of para. 543 for large *freight containers* and *tanks*, according to the appropriate category. In addition, each *package*, *overpack* and *freight container* containing *fissile material*, other than *fissile material* excepted under the provisions of para. 417, shall bear labels conforming to the model in Fig. 5. Any labels that do not relate to the contents shall be removed or covered.

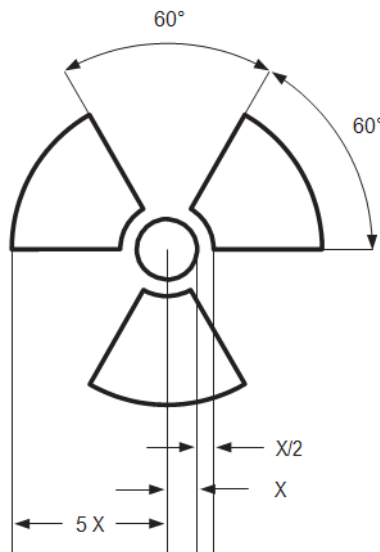

*FIG. 1. Basic trefoil symbol with proportions based on a central circle of radius  $X$ . The minimum allowable size of  $X$  shall be 4 mm.*

For *radioactive material* having other dangerous properties, see para. 507.

539. The labels conforming to the applicable models in Figs 2–4 shall be affixed to two opposite sides of the outside of a *package* or *overpack* or on the outside of all four sides of a *freight container* or *tank*. The labels conforming to the model in Fig. 5, where applicable, shall be affixed adjacent to the labels conforming to the applicable models in Figs 2–4. The labels shall not cover the markings specified in paras 531–536.

## Labelling for Radioactive contents

540. Each label conforming to the applicable models in Figs 2–4 shall be completed with the following information:

(a) Contents:

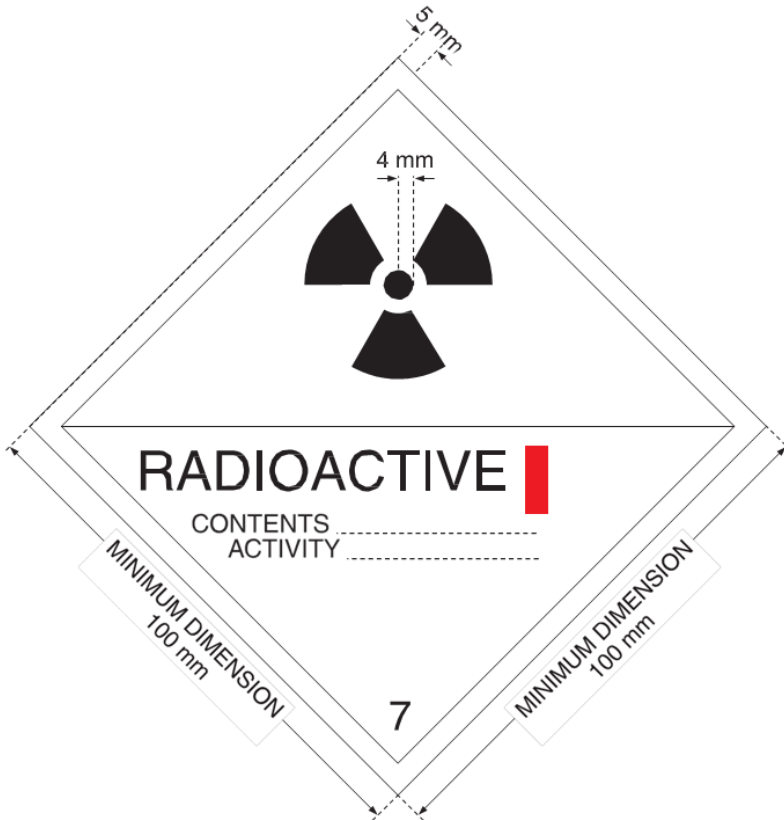

FIG 2. Category I-WHITE label. The minimum width of the line inside the edge forming the diamond shall be 2 mm. The background colour of the label shall be white, the colour of the trefoil and the printing shall be black, and the colour of the category bar shall be red.

(a) Contents:

- (i) Except for *LSA-I material*, the name(s) of the radionuclide(s) as taken from Table 2, using the symbols prescribed therein. For mixtures of radionuclides, the most restrictive nuclides must be listed to the extent the space on the line permits. The group of *LSA* or *SCO* shall be shown following the name(s) of the radionuclide(s). The terms “LSA-II”, “LSA-III”, “SCO-I”, “SCO-II” and SCO-III shall be used for this purpose.

- (ii) For *LSA-I material*, the term “LSA-I” is all that is necessary; the name of the radionuclide is not necessary.
- (b) Activity: The maximum activity of the *radioactive contents* during transport expressed in units of becquerels (Bq) with the appropriate SI prefix symbol (see Annex II). For *fissile material*, the total mass of *fissile nuclides* in units of grams (g), or multiples thereof, may be used in place of activity.
- (c) For *overpacks* and *freight containers*, the “contents” and “activity” entries on the label shall bear the information required in para. 540(a) and 540(b), respectively, totalled together for the entire contents of the *overpack* or *freight container* except that on labels for *overpacks* or *freight containers* containing mixed loads of *packages* containing different radionuclides, such entries may read “See Transport Documents”.

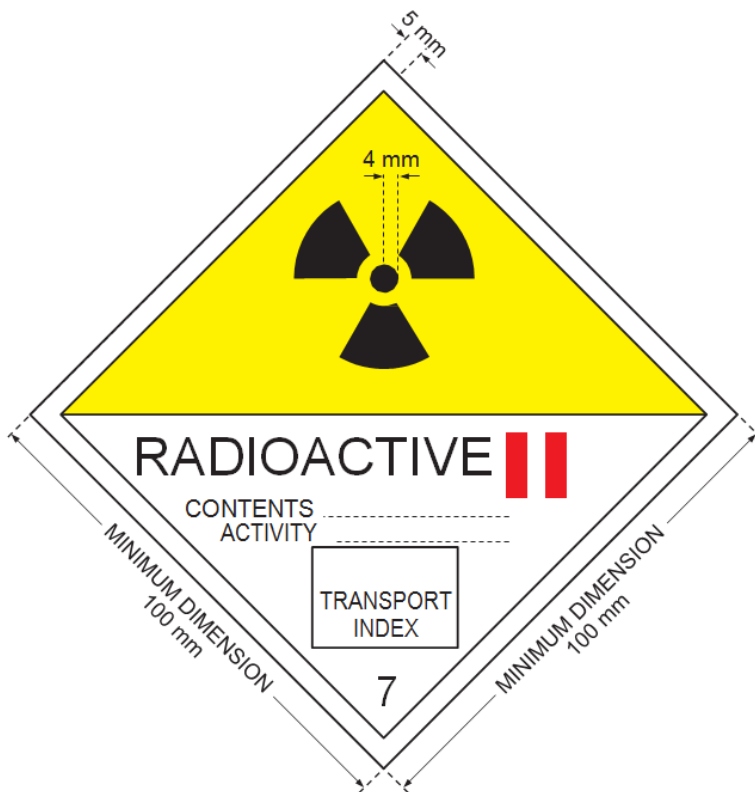

FIG 3. Category II-YELLOW label. The minimum width of the line inside the edge forming the diamond shall be 2 mm. The background colour of the upper half of the label shall be yellow and the lower half white, the colour of the trefoil and the printing shall be black, and the colour of the category bars shall be red.

(d) *TI*: The number determined in accordance with paras 523 and 524 (no *TI* entry is required for Category I-WHITE).

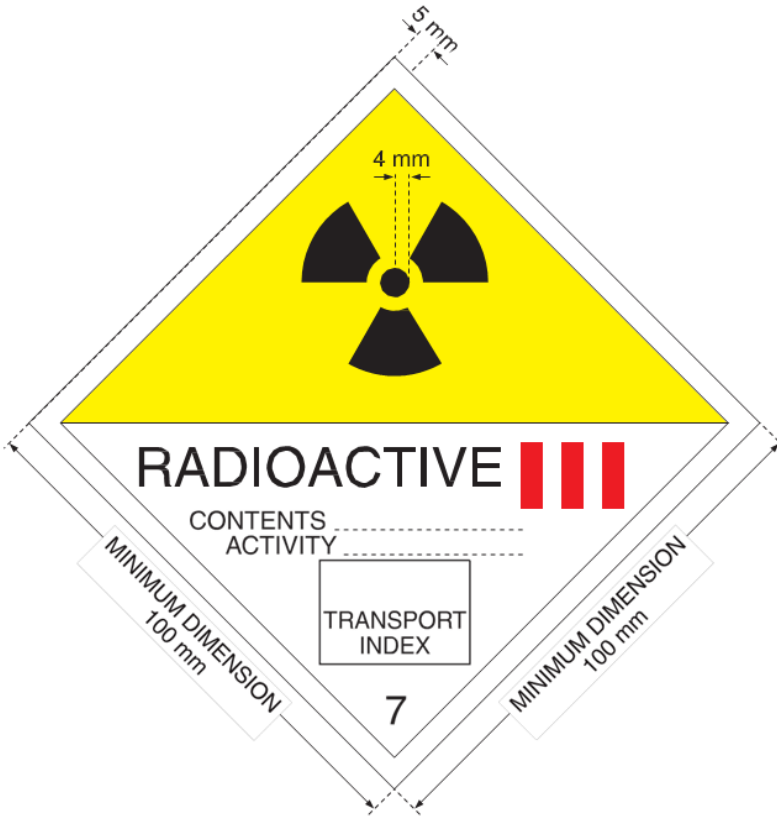

FIG 4. Category III-YELLOW label. The minimum width of the line inside the edge forming the diamond shall be 2 mm. The background colour of the upper half of the label shall be yellow and the lower half white, the colour of the trefoil and the printing shall be black, and the colour of the category bars shall be red.

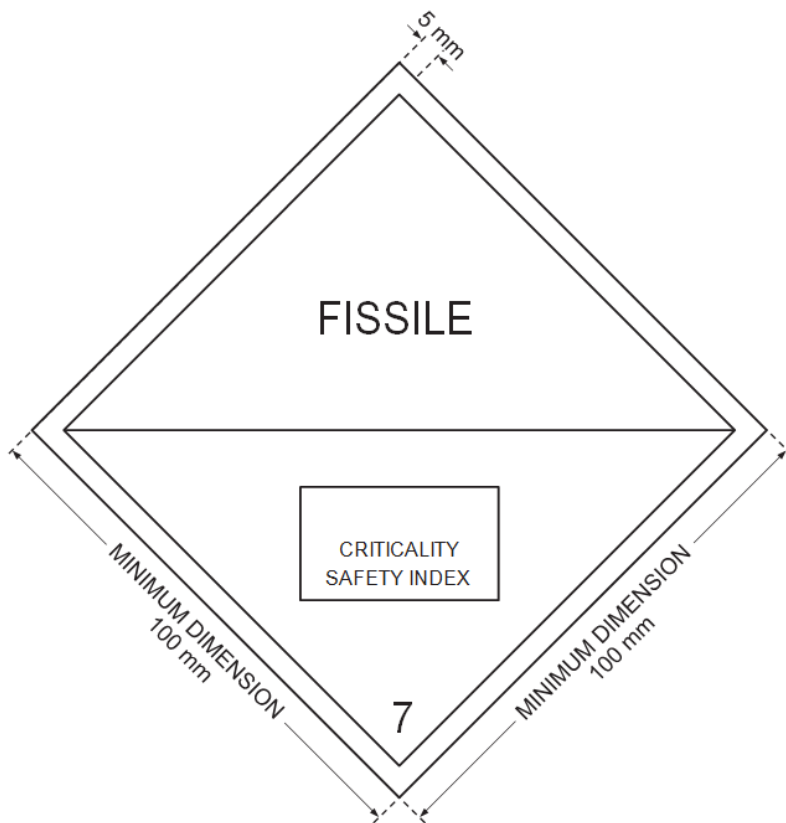

FIG 5. CSI label. The minimum width of the line inside the edge forming the diamond shall be 2 mm. The background colour of the label shall be white, the colour of the printing shall be black.

### Labelling for criticality safety

541. Each label conforming to the model in Fig. 5 shall be completed with the *CSI* as stated in the certificate of *approval* applicable in the countries *through or into* which the *consignment* is transported and issued by the *competent authority* or as specified in para. 674 or para. 675.

542. For *overpacks* and *freight containers*, the label conforming to the model in Fig. 5 shall bear the sum of the *CS* s of all the *packages* contained therein.

### Placarding

543. *Large freight containers* carrying unpacked LSA-I material or SCO-I or packages other than excepted packages, and tanks shall bear four placards that conform to the model given in Fig. 6. The placards shall be affixed in a vertical orientation to each side wall and to each end wall of the *large freight container* or *tank*. Any placards that do not relate to the contents shall be removed. Instead of using both labels and

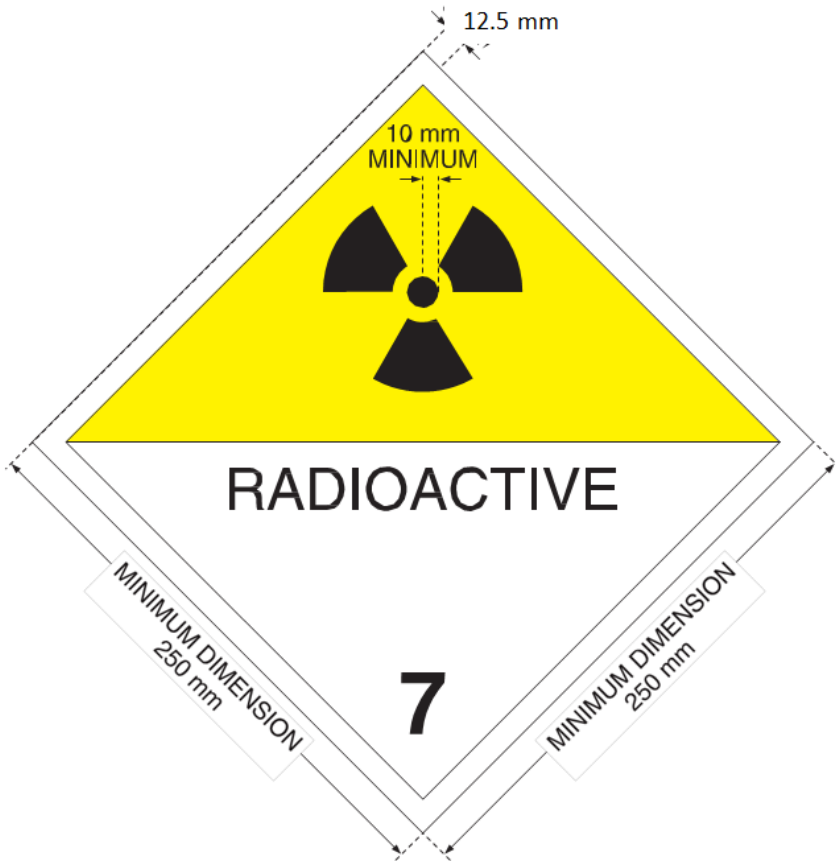

FIG 6. Placard. Except as permitted by para. 571, minimum dimensions shall be as shown; when different dimensions are used, the relative proportions shall be maintained. The number '7' shall not be less than 25 mm high. The background colour of the upper half of the placard shall be yellow and the lower half white, the colour of the trefoil and the printing shall be black. The use of the word "RADIOACTIVE" in the bottom half is optional, to allow the alternative use of this placard to display the appropriate UN number for the consignment.

placards, it is permitted, as an alternative, to use enlarged labels only, where appropriate, as shown in Figs 2–4, except having the minimum size shown in Fig. 6.

544. Where the *consignment* in the *freight container* or *tank* is unpackaged *LSA-I* or *SCO-I* or where a *consignment* in a *freight container* is required to be shipped under *exclusive use* and is packaged *radioactive material* with a single UN number, the appropriate UN number for the *consignment* (see Table 1) shall also be displayed, in black digits not less than 65 mm high, either:

- (a) In the lower half of the placard shown in Fig. 6 and against the white background;
  - or
- (b) On the placard shown in Fig. 7.

When the alternative given in (b) is used, the subsidiary placard shall be affixed immediately adjacent to the main placard, on all four sides of the *freight container* or *tank*.

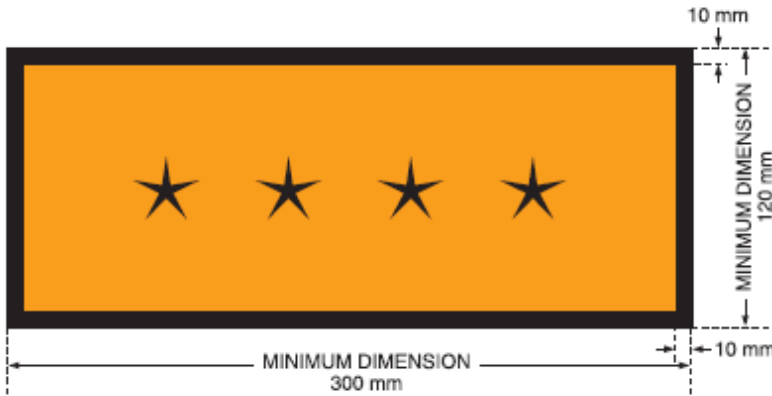

*FIG. 7. Placard for separate display of UN number. The background colour of the placard shall be orange and the border and UN number shall be black. The symbol “\*\*\*\*” denotes the space in which the appropriate UN number for radioactive material, as specified in Table 1, shall be displayed.*

## CONSIGNOR’S RESPONSIBILITIES

545. Except as otherwise provided in these Regulations, no person may offer *radioactive material* for transport unless it is properly marked, labelled, placarded, described and certified on a transport document, and otherwise in a condition for transport as required by these Regulations.

### **Particulars of consignment**

546. The *consignor* shall include in the transport documents with each *consignment* the identification of the *consignor* and *consignee*, including their names and addresses, and the following information, as applicable, in the order given:

- (a) The UN number assigned to the material as specified in accordance with the provisions of paras 401 and 530, preceded by the letters “UN”.
- (b) The proper shipping name, as specified in accordance with the provisions of paras 401 and 530.
- (c) The UN class number “7”.
- (d) The subsidiary hazard class or division number(s) corresponding to the subsidiary risk label(s) required to be applied, when assigned, shall be entered following the primary hazard class or division and shall be enclosed in parentheses.

- (e) The name or symbol of each radionuclide or, for mixtures of radionuclides, an appropriate general description or a list of the most restrictive nuclides.
- (f) A description of the physical and chemical form of the material, or a notation that the material is *special form radioactive material* or *low dispersible radioactive material*. A generic chemical description is acceptable for chemical form.
- (g) The maximum activity of the *radioactive contents* during transport expressed in units of becquerels (Bq) with the appropriate SI prefix symbol (see Annex II). For *fissile material*, the mass of *fissile material* (or mass of each *fissile nuclide* for mixtures, when appropriate) in units of grams (g), or appropriate multiples thereof, may be used in place of activity.
- (h) The category of the *package, overpack or freight container, as assigned per paragraph 529*, i.e. I-WHITE, II-YELLOW, III-YELLOW.
- (i) The *TI of the package, overpack or freight container, as assigned per paragraph 529* (categories II-YELLOW and III-YELLOW only).
- (j) For *fissile material*:
  - (i) Shipped under one exception of subparagraphs 417(a)–(f), reference to that para.;
  - (ii) Shipped under para. 417(c)–(e), the total mass of *fissile nuclides*;
  - (iii) Contained in a *package* for which one of para. 674(a)–(c) or 675 is applied, reference to that para.;
  - (iv) The *CSI*, where applicable.
- (k) The identification mark for each *competent authority certificate of approval* (*special form radioactive material*, *low dispersible radioactive material*, *fissile material* excepted under para. 417(f), *special arrangement*, *package design* or *shipment*) applicable to the *consignment*.
- (l) For *consignments* of more than one *package*, the information contained in para. 546(a)–(k) shall be given for each *package*. For *packages* in an *overpack, freight container* or *conveyance*, a detailed statement of the contents of each *package* within the *overpack, freight container* or *conveyance* and, where appropriate, of each *overpack, freight container* or *conveyance* shall be included. If *packages* are to be removed from the *overpack, freight container* or *conveyance* at a point of intermediate unloading, appropriate transport documents shall be made available.

- (m) Where a *consignment* is required to be shipped under *exclusive use*, the statement “EXCLUSIVE USE SHIPMENT”.
- (n) For *LSA-II*, *LSA-III*, *SCO-I*, *SCO-II* and *SCO-III*, the total activity of the *consignment* as a multiple of  $A_2$ . For *radioactive material* for which the  $A_2$  value is unlimited, the multiple of  $A_2$  shall be zero.

### **Consignor’s certification or declaration**

547. The *consignor* shall include in the transport documents a certification or declaration in the following terms:

“I hereby declare that the contents of this *consignment* are fully and accurately described above by the proper shipping name and are classified, packaged, marked and labelled/placarded, and are in all respects in proper condition for transport ~~in accordance with the~~according to applicable international and national governmental regulations.”

548. If the intent of the declaration is already a condition of transport within a particular international convention, the *consignor* need not provide such a declaration for that part of the transport covered by the convention.

549. The declaration shall be signed and dated by the *consignor*. Facsimile signatures are acceptable where applicable laws and regulations recognize the legal validity of facsimile signatures.

550. If the dangerous goods documentation is presented to the *carrier* by means of electronic data processing (EDP) or electronic data interchange (EDI) transmission techniques, the signature(s) may be replaced by the name(s) (in capitals) of the person authorized to sign.

551. When *radioactive material*, other than when carried in *tanks*, is packed or loaded into any *freight container* or *vehicle* that will be transported by sea, those responsible for packing the container or *vehicle* shall provide a container/*vehicle* packing certificate specifying the container/*vehicle* identification number(s) and certifying that the operation has been carried out in accordance with the applicable conditions of the IMDG Code [8].

552. The information required in the transport documents and the container/*vehicle* packing certificate may be incorporated into a single document, if not, the documents shall be attached one to the other. If the information is incorporated into a single document, the document shall include a signed declaration such as:

“It is declared that the packing of the goods into the container/vehicle has been carried out in accordance with the applicable provisions”.

This declaration shall be dated and the person signing it shall be identified on the document. Facsimile signatures are acceptable where applicable laws and regulations recognize the legal validity of facsimile signatures.

553. The declaration shall be made on the same transport document that contains the particulars of *consignment* listed in para. 546.

### **Information for carriers**

554. The *consignor* shall provide in the transport documents a statement regarding actions, if any, that are required to be taken by the *carrier*. The statement shall be in the languages deemed necessary by the *carrier* or the authorities concerned and shall include at least the following points:

- (a) Supplementary requirements for loading, stowage, carriage, handling and unloading of the *package*, *overpack* or *freight container*, including any special stowage provisions for the safe dissipation of heat (see para. 565), or a statement that no such requirements are necessary;
- (b) Restrictions on the mode of transport or *conveyance* and any necessary routing instructions;
- (c) Emergency arrangements appropriate to the *consignment*.

555. The *consignor* shall retain a copy of each of the transport documents containing the information specified in paras 546, 547, 551, 552 and 554, as applicable, for a minimum period of three months.

When the documents are kept electronically, the *consignor* shall be able to reproduce them in a printed form.

556. The applicable *competent authority* certificates need not necessarily accompany the *consignment*. The *consignor* shall make them available to the *carrier(s)* before loading and unloading.

### **Notification of competent authorities**

557. Before the first *shipment* of any *package* requiring *competent authority approval*, ~~the each~~ *consignor* shall ensure that copies of each applicable *competent authority* certificate applying to that *package design* have been submitted to the *competent authority* of the country of origin of the *shipment* and to the *competent authority* of each country through or into which the *consignment* is to be transported. The *consignor*

is not required to await an acknowledgement from the *competent authority*, nor is the *competent authority* required to make such acknowledgement of receipt of the certificate.

558. For each *shipment* listed in (a), (b), (c) or (d) below, the *consignor* shall notify the *competent authority* of the country of origin of the *shipment* and the *competent authority* of each country *through or into* which the *consignment* is to be transported. This notification shall be in the hands of each *competent authority* prior to the commencement of the *shipment*, and preferably at least 7 days in advance.

- (a) *Type C packages* containing *radioactive material* with an activity greater than 3000  $A_1$  or 3000  $A_2$ , as appropriate, or 1000 TBq, whichever is the lower;
- (b) *Type B(U) packages* containing *radioactive material* with an activity greater than 3000  $A_1$  or 3000  $A_2$ , as appropriate, or 1000 TBq, whichever is the lower;
- (c) *Type B(M) packages*;
- (d) *Shipments* under *special arrangement*.

559. The *consignment* notification shall include:

- (a) Sufficient information to enable the identification of the *package* or *packages*, including all applicable certificate numbers and identification marks.
- (b) Information on the date of *shipment*, the expected date of arrival and the proposed routing.
- (c) The name(s) of the *radioactive material*(s) or nuclide(s).
- (d) Descriptions of the physical and chemical forms of the *radioactive material*, or whether it is *special form radioactive material* or *low dispersible radioactive material*.
- (e) The maximum activity of the *radioactive contents* during transport expressed in units of becquerels (Bq) with the appropriate SI prefix symbol (see Annex II). For *fissile material*, the mass of *fissile material* (or the mass of each *fissile nuclide* for a mixture, when appropriate) in units of grams (g), or multiples thereof, may be used in place of activity.

560. The *consignor* is not required to send a separate notification if the required information has been included in the application for *approval* of *shipment* (see para. 827).

### **Possession of certificates and instructions**

561. The *consignor* shall have in his/her possession a copy of each certificate required under Section VIII of these Regulations and a copy of the instructions with regard to the proper closing of the *package* and other preparations for *shipment* before making any *shipment* under the terms of the certificates.

## TRANSPORT AND STORAGE IN TRANSIT

### **Segregation during transport and storage in transit**

562. *Packages, overpacks and freight containers* containing *radioactive material* and unpackaged *radioactive material* shall be segregated during transport and during storage in transit:

- (a) From workers in regularly occupied working areas by distances calculated using a dose criterion of 5 mSv in a year and conservative model parameters;
- (b) From members of the public in areas where the public has regular access by distances calculated using a dose criterion of 1 mSv in a year and conservative model parameters;
- (c) From undeveloped photographic film by distances calculated using a radiation exposure criterion for undeveloped photographic film due to the transport of *radioactive material* of 0.1 mSv per *consignment* of such film;
- (d) From other dangerous goods in accordance with para. 506.

563. Category II-YELLOW or III-YELLOW *packages* or *overpacks* shall not be carried in compartments occupied by passengers, except those exclusively reserved for couriers specially authorized to accompany such *packages* or *overpacks*.

### **Stowage during transport and storage in transit**

564. *Consignments* shall be securely stowed.

565. Provided that its average surface heat flux does not exceed  $15 \text{ W/m}^2$  and that the immediate surrounding cargo is not in sacks or bags, a *package* or *overpack* may be carried or stored among packaged general cargo without any special stowage provisions except as may be specifically required by the *competent authority* in an applicable certificate of *approval*.

566. Loading of *freight containers* and accumulation of *packages, overpacks and freight containers* shall be controlled as follows:

- (a) Except under the condition of *exclusive use*, and for *consignments* of *LSA-I material*, the total number of *packages, overpacks and freight containers* aboard a

single conveyance shall be so limited that the sum of the *TIs* aboard the conveyance does not exceed the values shown in Table 10.

(b) The ~~radiation level~~ *dose equivalent rate* under routine conditions of transport shall not exceed 2 mSv/h at any point on, and 0.1 mSv/h at 2 m from, the external surface of the ~~conveyance~~ *vehicle or freight container*, except for consignments transported under exclusive use by road or rail, for which the radiation limits around the vehicle are set forth in para. 573(b) and 573(c). (c) The sum of the *CSIs* in a freight container and aboard a conveyance shall not exceed the values shown in Table 11.

TABLE 10. TRANSPORT INDEX LIMITS FOR FREIGHT CONTAINERS AND CONVEYANCES NOT UNDER EXCLUSIVE USE

Type of freight container or conveyance	Limit on sum of <i>TIs</i> in a freight container or aboard a conveyance
<i>Freight container:</i>	
<i>Small freight container</i>	50
<i>Large freight container</i>	50
<i>Vehicle</i>	50
<i>Aircraft:</i>	
Passenger	50
Cargo	200
Inland waterway craft	50
<i>Seagoing vessel<sup>a</sup>:</i>	
(i) Hold, compartment or defined deck area:	
<i>Packages, Overpacks, small freight containers</i>	50
<i>Large freight containers</i>	200
(ii) Total vessel:	
<i>Packages, Overpacks, small freight containers</i>	200
<i>Large freight containers</i>	No limit

<sup>a</sup> *Packages* or *Overpacks* carried in or on a vehicle that are in accordance with the provisions of para. 573 may be transported by vessels provided that they are not removed from the vehicle at any time while on board the vessel.

567. Any package or Overpack having a TI greater than 10, or any consignment having a CSI greater than 50, shall be transported only under exclusive use.

### Additional requirements relating to transport and storage in transit of fissile material

568. Any group of packages, overpacks and freight containers containing fissile material stored in transit in any one storage area shall be so limited that the sum of the

CSIs in the group does not exceed 50. Each group shall be stored so as to maintain a spacing of at least 6 m from other such groups.

569. Where the sum of the CSIs on board a conveyance or in a freight container exceeds 50, as permitted in Table 11, storage shall be such as to maintain a spacing of at least 6 m from other groups of packages, overpacks or freight containers containing fissile material or other conveyances carrying radioactive material.

570. Fissile material meeting one of the provisions (a)–(f) of para. 417 shall meet the following requirements:

- (a) Only one of the provisions (a)–(f) of para. 417 is allowed per consignment.
- (b) Only one approved fissile material in packages classified in accordance with para. 417(f) is allowed per consignment unless multiple materials are authorized in the certificate of approval.
- (c) Fissile material in packages classified in accordance with para. 417(c) shall be transported in a consignment with no more than 45 g of fissile nuclides .
- (d) Fissile material in packages classified in accordance with para. 417(d) shall be transported in a consignment with no more than 15 g of fissile nuclides .
- (e) Unpackaged or packaged fissile material classified in accordance with para. 417(e) shall be transported under exclusive use on a conveyance with no more than 45 g of fissile nuclides .

TABLE 11. CSI LIMITS FOR FREIGHT CONTAINERS AND CONVEYANCES CONTAINING FISSILE MATERIAL

---

Type of freight container or conveyance	Limit on sum of <i>CSI s</i> in a freight container or aboard a conveyance	
	Not under <i>exclusive use</i>	Under <i>exclusive use</i>
<i>Freight container:</i>		
<i>Small freight container</i>	50	Not applicable
<i>Large freight container</i>	50	100
<i>Vehicle</i>	50	100
<i>Aircraft:</i>		
Passenger	50	Not applicable
Cargo	50	100
Inland waterway craft	50	100
<i>Seagoing Vessel <sup>a</sup>:</i>		
(i) Hold, compartment or defined deck area:		
<i>Packages, Overpacks, small freight containers</i>	50	100
<i>Large freight containers</i>	50	100
(ii) Total vessel: <i>Packages, Overpacks, small freight containers Large freight containers</i>	200 <sup>b</sup> No limit <sup>b</sup>	200 <sup>c</sup> No limit <sup>c</sup>

<sup>a</sup> *Packages* or *Overpacks* carried in or on a *vehicle* that are in accordance with the provisions of para. 573 may be transported by *vessels* provided that they are not removed from the *vehicle* at any time while on board the *vessel*. In this case, the entries under the heading “under *exclusive use*” apply.

<sup>b</sup> The *consignment* shall be so handled and stowed that the sum of *CSI s* in any group does not exceed 50 and that each group is handled and stowed so as to maintain a spacing of at least 6 m from other groups.

<sup>c</sup> The *consignment* shall be so handled and stowed that the sum of *CSI s* in any group does not exceed 100 and that each group is handled and stowed so as to maintain a spacing of at least 6 m from other groups. The intervening space between groups may be occupied by other cargo in accordance with para. 506.

### **Additional requirements relating to transport by rail and by road**

571. Rail and road *vehicles* carrying *packages, overpacks* or *freight containers* labelled with any of the labels shown in Figs 2–5, or carrying **unpacked LSA-I material or SCO-I or consignments under exclusive use**, shall display the placard shown in Fig. 6 on each of:

(a) The two external lateral walls in the case of a rail *vehicle*;

(b) The two external lateral walls and the external rear wall in the case of a road *vehicle*.

In the case of a *vehicle* without sides, the placards may be affixed directly on the cargo carrying unit provided that they are readily visible. In the case of large tanks or *freight containers*, the placards on the *tanks* or *freight containers* shall suffice. In the case of *vehicles* that have insufficient area to allow the fixing of larger placards, the dimensions of the placard described in Fig. 6 may be reduced to 100 mm. Any placards that do not relate to the contents shall be removed.

572. Where the *consignment* in or on the *vehicle* is unpackaged *LSA-I material*, ~~or~~ *SCO-I or SCO-III*, or where a *consignment* is required to be shipped under *exclusive use* and is packaged *radioactive material* with a single UN number, the appropriate UN number (see Table 1) shall also be displayed, in black digits not less than 65 mm high, either:

- (a) In the lower half of the placard shown in Fig. 6, against the white background; or
- (b) On the placard shown in Fig. 7.

When the alternative given in (b) is used, the subsidiary placard shall be affixed immediately adjacent to the main placard, either on the two external lateral walls in the case of a rail *vehicle* or on the two external lateral walls and the external rear wall in the case of a road *vehicle*.

573. For *consignments* under *exclusive use*, the ~~radiation level~~ *dose equivalent rate* shall not exceed:

- a) 10 mSv/h at any point on the external surface of any *package* or *overpack*, and may only exceed 2 mSv/h provided that:
  - (i) The *vehicle* is equipped with an enclosure that, during routine conditions of transport, prevents the access of unauthorized persons to the interior of the enclosure.
  - (ii) Provisions are made to secure the *package* or *overpack* so that its position within the *vehicle* enclosure remains fixed during routine conditions of transport.
  - (iii) There is no loading or unloading during the *shipment*.
- (b) 2 mSv/h at any point on the outer surfaces of the *vehicle*, including the upper and lower surfaces, or, in the case of an open *vehicle*, at any point on the vertical planes projected from the outer edges of the *vehicle*, on the upper surface of the load, and on the lower external surface of the *vehicle*.

(c) 0.1 mSv/h at any point 2 m from the vertical planes represented by the outer lateral surfaces of the *vehicle*, or, if the load is transported in an open *vehicle*, at any point 2 m from the vertical planes projected from the outer edges of the *vehicle*.

574. In the case of road *vehicles*, no persons other than the driver and assistants shall be permitted in *vehicles* carrying *packages*, *overpacks* or *freight containers* bearing category II-YELLOW or III-YELLOW labels.

#### **Additional requirements relating to transport by vessels**

575. *Packages* or *overpacks* having a surface ~~radiation level~~ dose equivalent rate greater than 2 mSv/h, unless being carried in or on a *vehicle* under *exclusive use* in accordance with Table 10, footnote (a), shall not be transported by *vessel* except under *special arrangement*.

576. The transport of *consignments* by means of a special use *vessel* that, by virtue of its *design*, or by reason of its being chartered, is dedicated to the purpose of carrying *radioactive material*, shall be excepted from the requirements specified in para. 566 provided that the following conditions are met:

- (a) A *Radiation protection programme* for the *shipment* shall be approved by the *competent authority* of the flag state of the *vessel* and, when requested, by the *competent authority* at each port of call.
- (b) Stowage arrangements shall be predetermined for the whole voyage, including any *consignments* to be loaded at ports of call en route.
- (c) The loading, carriage and unloading of the *consignments* shall be supervised by persons qualified in the transport of *radioactive material*.

#### **Additional requirements relating to transport by air**

577. *Type B(M) packages* and *consignments* under *exclusive use* shall not be transported on passenger *aircraft*.

578. Vented *Type B(M) packages*, *packages* that require external cooling by an ancillary cooling system, *packages* subject to operational controls during transport and *packages* containing liquid pyrophoric materials shall not be transported by air.

579. *Packages* or *overpacks* having a surface ~~radiation level~~ dose equivalent rate greater than 2 mSv/h shall not be transported by air except by *special arrangement*.

#### **Additional requirements relating to transport by post**

580. A *consignment* that conforms to the requirements of para. 515, in which the activity of the *radioactive contents* does not exceed one tenth of the limits prescribed in

Table 4, and that does not contain uranium hexafluoride, may be accepted for domestic movement by national postal authorities, subject to such additional requirements as those authorities may prescribe.

581. A *consignment* that conforms to the requirements of para. 515, in which the activity of the *radioactive contents* does not exceed one tenth of the limits prescribed in Table 4, and that does not contain uranium hexafluoride, may be accepted for international movement by post, subject in particular to the following additional requirements as prescribed by the Acts of the Universal Postal Union:

- (a) It shall be deposited with the postal service only by *consignors* authorized by the national authority.
- (b) It shall be dispatched by the quickest route, normally by air.
- (c) It shall be plainly and durably marked on the outside with the words “RADIOACTIVE MATERIAL — QUANTITIES PERMITTED FOR MOVEMENT BY POST”. These words shall be crossed out if the *packaging* is returned empty.
- (d) It shall carry on the outside the name and address of the *consignor* with the request that the *consignment* be returned in the case of non-delivery.
- (e) The name and address of the *consignor* and the contents of the *consignment* shall be indicated on the internal *packaging*.

#### CUSTOMS OPERATIONS

582. Customs operations involving the inspection of the *radioactive contents* of a *package* shall be carried out only in a place where adequate means of controlling radiation exposure are provided and in the presence of qualified persons. Any *package* opened on customs instructions shall, before being forwarded to the *consignee*, be restored to its original condition.

#### UNDELIVERABLE CONSIGNMENTS

583. Where a *consignment* is undeliverable, it shall be placed in a safe location and the appropriate *competent authority* shall be informed as soon as possible and a request made for instructions on further action.

#### RETENTION AND AVAILABILITY OF TRANSPORT DOCUMENTS BY CARRIERS

584. A *carrier* shall not accept a *consignment* for transport unless:

(a) A copy of the transport document and other documents or information as required by these Regulations are provided; or

(b) The information applicable to the *consignment* is provided in electronic form.

585. The information applicable to the *consignment* shall accompany the *consignment* to final destination. This information may be on the transport document or may be on another document. This information shall be given to the *consignee* when the *consignment* is delivered.

586. When the information applicable to the *consignment* is given to the *carrier* in electronic form, the information shall be available to the *carrier* at all times during transport to final destination. The information shall be able to be produced without delay as a paper document.

587. The *carrier* shall retain a copy of the transport document and additional information and documentation, as specified in these Regulations, for a minimum period of three months.

588. When the documents are kept electronically or in a computer system, the *carrier* shall be capable of reproducing them in a printed form.

**Section VI**  
**REQUIREMENTS FOR RADIOACTIVE MATERIAL AND FOR**  
**PACKAGINGS AND PACKAGES**

REQUIREMENTS FOR RADIOACTIVE MATERIAL

**Requirements for LSA-III material**

~~601. LSA-III material shall be a solid of such a nature that if the entire contents of a package were subjected to the test specified in para. 703, the activity in the water would not exceed 0.1A2.~~

**Requirements for special form radioactive material**

602. *Special form radioactive material* shall have at least one dimension of not less than 5 mm.

603. *Special form radioactive material* shall be of such a nature or shall be so designed that if it is subjected to the tests specified in paras 704–711, it shall meet the following requirements:

- (a) It would not break or shatter under the impact, percussion and bending tests in paras 705–707 and 709(a), as applicable.
- (b) It would not melt or disperse in the heat test in para. 708 or para. 709(b), as applicable.
- (c) The activity in the water from the leaching tests specified in paras 710 and 711 would not exceed 2 kBq; or alternatively, for sealed sources, the leakage rate for the volumetric leakage assessment test specified in the International Organization for Standardization document ISO 9978: Radiation Protection — Sealed Radioactive Sources — Leakage Test Methods [9], would not exceed the applicable acceptance threshold acceptable to the *competent authority*.

604. When a sealed capsule constitutes part of the *special form radioactive material*, the capsule shall be so manufactured that it can be opened only by destroying it.

**Requirements for low dispersible radioactive material**

605. Low dispersible *radioactive material* shall be such that the total amount of this *radioactive material* in a *package* shall meet the following requirements:

- (a) The ~~radiation level~~ dose equivalent rate at 3 m from the unshielded *radioactive material* does not exceed 10 mSv/h.

- (b) If subjected to the tests specified in paras 736 and 737, the airborne release in gaseous and particulate forms of up to 100  $\mu\text{m}$  aerodynamic equivalent diameter would not exceed 100  $A_2$ . A separate specimen may be used for each test.
- (c) If subjected to the test specified in para. 703, the activity in the water would not exceed 100  $A_2$ . In the application of this test, the damaging effects of the tests specified in (b) shall be taken into account.

## REQUIREMENTS FOR MATERIAL EXCEPTED FROM FISSILE CLASSIFICATION

606. A *fissile material* excepted from classification as “FISSILE” under para. 417(f) shall be subcritical without the need for accumulation control under the following conditions:

- (a) The conditions of para. 673(a);
- (b) The conditions consistent with the assessment provisions stated in paras 684(b) and 685(b) for *packages*;
- (c) The conditions specified in para. 683(a), if transported by air.

## GENERAL REQUIREMENTS FOR ALL PACKAGINGS AND PACKAGES

607. The *package* shall be so designed in relation to its mass, volume and shape that it can be easily and safely transported. In addition, the *package* shall be so designed that it can be properly secured in or on the *conveyance* during transport.

608. The *design* shall be such that any lifting attachments on the *package* will not fail when used in the intended manner and that if failure of the attachments should occur, the ability of the *package* to meet other requirements of these Regulations would not be impaired. The *design* shall take account of appropriate safety factors to cover snatch lifting.

609. Attachments and any other features on the outer surface of the *package* that could be used to lift it shall be designed either to support its mass in accordance with the requirements of para. 608 or shall be removable or otherwise rendered incapable of being used during transport.

610. As far as practicable, the *packaging* shall be so designed and finished that the external surfaces are free from protruding features and can be easily decontaminated.

611. As far as practicable, the outer layer of the *package* shall be so designed as to prevent the collection and the retention of water.

612. Any features added to the *package* at the time of transport that are not part of the *package* shall not reduce its safety.

613. The *package* shall be capable of withstanding the effects of any acceleration, vibration or vibration resonance that may arise under routine conditions of transport without any deterioration in the effectiveness of the closing devices on the various receptacles or in the integrity of the *package* as a whole. In particular, nuts, bolts and other securing devices shall be so designed as to prevent them from becoming loose or being released unintentionally, even after repeated use.

613bis. The design of packages shall take into account ageing mechanisms.

614. The materials of the *packaging* and any components or structures shall be physically and chemically compatible with each other and with the *radioactive contents*. Account shall be taken of their behaviour under irradiation.

615. All valves through which the *radioactive contents* could escape shall be protected against unauthorized operation.

616. The *design* of the *package* shall take into account ambient temperatures and pressures that are likely to be encountered in routine conditions of transport.

617. A *package* shall be so designed that it provides sufficient shielding to ensure that, under routine conditions of transport and with the maximum *radioactive contents* that the *package* is designed to contain, the ~~radiation level~~ *dose equivalent rate* at any point on the external surface of the *package* would not exceed the values specified in paras 516, 527 and 528, as applicable, with account taken of paras 566(b) and 573.

618. For *radioactive material* having other dangerous properties, the *package design* shall take into account those properties (see paras 110 and 507).

#### ADDITIONAL REQUIREMENTS FOR PACKAGES TRANSPORTED BY AIR

619. For *packages* to be transported by air, the temperature of the accessible surfaces shall not exceed 50°C at an ambient temperature of 38°C with no account taken for insolation.

620. *Packages* to be transported by air shall be so designed that if they were exposed to ambient temperatures ranging from -40°C to +55°C, the integrity of containment would not be impaired.

621. *Packages* containing *radioactive material* to be transported by air shall be capable of withstanding, without loss or dispersal of *radioactive contents* from the *containment system*, an internal pressure that produces a pressure differential of not less than *maximum normal operating pressure* plus 95 kPa.

## REQUIREMENTS FOR EXCEPTED PACKAGES

622. An *excepted package* shall be designed to meet the requirements specified in paras 607–618 and, in addition, the requirements of para. 636 if it contains fissile material allowed per para. 417 and the requirements of paras 619–621 if carried by air.

## REQUIREMENTS FOR INDUSTRIAL PACKAGES

### Requirements for Type IP-1

623. A *Type IP-1 package* shall be designed to meet the requirements specified in paras 607–618 and 636 and, in addition, the requirements of paras 619–621 if carried by air.

### Requirements for Type IP-2

624. A *package* to be qualified as *Type IP-2* shall be designed to meet the requirements for *Type IP-1* as specified in para. 623 and, in addition, if it were subjected to the tests specified in paras 722 and 723, it would prevent:

- (a) Loss or dispersal of the *radioactive contents*;
- (b) More than a 20% increase in the maximum ~~radiation level~~dose equivalent rate at any external surface of the *package*, except when the maximum dose equivalent rate on the external surface is below 10  $\mu\text{Sv/h}$ . In this case, there shall be no increase of more than 2  $\mu\text{Sv/h}$  in the maximum dose equivalent rate at any external surface of the *package*.

### Requirements for Type IP-3

625. A *package* to be qualified as *Type IP-3* shall be designed to meet the requirements for *Type IP-1* as specified in para. 623 and, in addition, the requirements specified in paras 636–649.

### Alternative requirements for Type IP-2 and Type IP-3

626. *Packages* may be used as *Type IP-2*, provided that:

- (a) They satisfy the requirements for *Type IP-1* specified in para. 623.
- (b) They are designed to satisfy the requirements prescribed for UN Packing Group I or II in Chapter 6.1 of the United Nations Recommendations on the Transport of Dangerous Goods, Model Regulations [10].
- (c) When subjected to the tests required for UN Packing Group I or II, they would prevent:
  - (i) Loss or dispersal of the *radioactive contents*;

(ii) More than a 20% increase in the maximum ~~radiation level~~dose equivalent rate at any external surface of the *package*-, except when the maximum dose equivalent rate on the external surface is below 10  $\mu$ Sv/h. In this case, there shall be no increase of more than 2  $\mu$ Sv/h in the maximum dose equivalent rate at any external surface of the *package*.

627. Portable *tanks* may also be used as *Type IP-2* or *Type IP-3*, provided that:

- (a) They satisfy the requirements for *Type IP-1* specified in para. 623.
- (b) They are designed to satisfy the requirements prescribed in Chapter 6.7 of the United Nations Recommendations on the Transport of Dangerous Goods, Model Regulations [10], or other requirements, at least equivalent, and are capable of withstanding a test pressure of 265 kPa.
- (c) They are designed so that any additional shielding that is provided shall be capable of withstanding the static and dynamic stresses resulting from handling and routine conditions of transport and of preventing more than a 20% increase in the maximum ~~radiation level~~dose equivalent rate at any external surface of the portable *tanks*-, except when the maximum dose equivalent rate on the external surface is below 10  $\mu$ Sv/h. In this case, there shall be no increase of more than 2  $\mu$ Sv/h in the maximum dose equivalent rate at any external surface of the portable *tanks*.

628. *Tanks*, other than portable *tanks*, may also be used as *Type IP-2* or *Type IP-3* for transporting *LSA-I* and *LSA-II* ~~liquids and gases~~ as prescribed in Table 5, provided that:

- (a) They satisfy the requirements for *Type IP-1* specified in para. 623.
- (b) They are designed to satisfy the requirements prescribed in regional or national regulations for the transport of dangerous goods and are capable of withstanding a test pressure of 265 kPa.
- (c) They are designed so that any additional shielding that is provided shall be capable of withstanding the static and dynamic stresses resulting from handling and routine conditions of transport and of preventing more than a 20% increase in the maximum ~~radiation level~~dose equivalent rate at any external surface of the *tanks*-, except when the maximum dose equivalent rate on the external surface is below 10  $\mu$ Sv/h. In this case, there shall be no increase of more than 2  $\mu$ Sv/h in the maximum dose equivalent rate at any external surface of the *tanks*.

629. *Freight containers* with the characteristics of a permanent enclosure may also be used as *Type IP-2* or *Type IP-3*, provided that:

- (a) The *radioactive contents* are restricted to solid materials.
- (b) They satisfy the requirements for *Type IP-1* specified in para. 623.
- (c) They are designed to conform to the International Organization for Standardization document ISO 1496/1: Series 1 *Freight containers* — Specifications and Testing — Part 1: General Cargo Containers for General Purposes [11] excluding dimensions and ratings. They shall be designed such that if subjected to the tests prescribed in that document and to the accelerations occurring during routine conditions of transport they would prevent:
  - (i) Loss or dispersal of the *radioactive contents*;
  - (ii) More than a 20% increase in the maximum ~~radiation level~~*dose equivalent rate* at any external surface of the *freight containers*, except when the maximum dose equivalent rate on the external surface is below 10  $\mu$ Sv/h. In this case, there shall be no increase of more than 2  $\mu$ Sv/h in the maximum dose equivalent rate at any external surface of the *freight containers*.

630. Metal *IBCs* may also be used as *Type IP-2* or *Type IP-3*, provided that:

- (a) They satisfy the requirements for *Type IP-1* specified in para. 623.
- (b) They are designed to satisfy the requirements prescribed for UN Packing Group I or II in Chapter 6.5 of the United Nations Recommendations on the Transport of Dangerous Goods, Model Regulations [10], and if they were subjected to the tests prescribed in that document, but with the drop test conducted in the most damaging orientation, they would prevent:
  - (i) Loss or dispersal of the *radioactive contents*;
  - (ii) More than a 20% increase in the maximum ~~radiation level~~*dose equivalent rate* at any external surface of the *IBC*, except when the maximum dose equivalent rate on the external surface is below 10  $\mu$ Sv/h. In this case, there shall be no increase of more than 2  $\mu$ Sv/h in the maximum dose equivalent rate at any external surface of the *IBC*.

#### REQUIREMENTS FOR PACKAGES CONTAINING URANIUM HEXAFLUORIDE

631. *Packages* designed to contain uranium hexafluoride shall meet the requirements that pertain to the radioactive and fissile properties of the material prescribed elsewhere in these Regulations. Except as allowed in para. 634, uranium hexafluoride in quantities of 0.1 kg or more shall also be packaged and transported in accordance with the provisions of the International Organization for Standardization document ISO

7195: *Packaging* of Uranium Hexafluoride (UF<sub>6</sub>) for Transport [12], and the requirements of paras 632 and 633.

632. Each *package* designed to contain 0.1 kg or more of uranium hexafluoride shall be designed so that it will meet the following requirements:

- (a) Withstand, without leakage and without unacceptable stress, as specified in ISO 7195 [12], the structural test as specified in para. 718, except as allowed in para. 634;
- (b) Withstand, without loss or dispersal of the uranium hexafluoride, the free drop test specified in para. 722;
- (c) Withstand, without rupture of the *containment system*, the thermal test specified in para. 728, except as allowed in para. 634.

633. *Packages* designed to contain 0.1 kg or more of uranium hexafluoride shall not be provided with pressure relief devices.

634. Subject to *multilateral approval*, *packages* designed to contain 0.1 kg or more of uranium hexafluoride may be transported if the *packages* are designed :

- (a) To international or national standards other than ISO 7195 [12], provided an equivalent level of safety is maintained; and/or
- (b) To withstand, without leakage and without unacceptable stress, a test pressure of less than 2.76 MPa as specified in para. 718; and/or
- (c) To contain 9000 kg or more of uranium hexafluoride and the *packages* do not meet the requirement of para. 632(c).

In all other respects, the requirements specified in paras 631–633 shall be satisfied.

#### REQUIREMENTS FOR TYPE A PACKAGES

635. *Type A packages* shall be designed to meet the requirements specified in paras 607–618 and, in addition, the requirements of paras 619–621 if carried by air, and of paras 636–651.

636. The smallest overall external dimension of the *package* shall not be less than 10 cm.

637. The outside of the *package* shall incorporate a feature such as a seal that is not readily breakable and which, while intact, will be evidence that the *package* has not been opened.

638. Any tie-down attachments on the *package* shall be so designed that, under normal and accident conditions of transport, the forces in those attachments shall not impair the ability of the *package* to meet the requirements of these Regulations.

639. The *design* of the *package* shall take into account temperatures ranging from –40°C to +70°C for the components of the *packaging*. Attention shall be given to freezing temperatures for liquids and to the potential degradation of *packaging* materials within the given temperature range.

640. The *design* and manufacturing techniques shall be in accordance with national or international standards, or other requirements, acceptable to the *competent authority*.

641. The *design* shall include a containment system securely closed by a positive fastening device that cannot be opened unintentionally or by a pressure that may arise within the *package*.

642. *Special form radioactive material* may be considered as a component of the containment system.

643. If the containment system forms a separate unit of the *package*, it shall be capable of being securely closed by a positive fastening device that is independent of any other part of the *packaging*.

644. The *design* of any component of the containment system shall take into account, where applicable, the radiolytic decomposition of liquids and other vulnerable materials and the generation of gas by chemical reaction and radiolysis.

645. The containment system shall retain its *radioactive contents* under a reduction of ambient pressure to 60 kPa.

646. All valves, other than pressure relief valves, shall be provided with an enclosure to retain any leakage from the valve.

647. A radiation shield that encloses a component of the *package* specified as a part of the containment system shall be so designed as to prevent the unintentional release of that component from the shield. Where the radiation shield and such component within it form a separate unit, the radiation shield shall be capable of being securely closed by a positive fastening device that is independent of any other *packaging* structure.

648. A *package* shall be so designed that if it were subjected to the tests specified in paras 719–724, it would prevent:

(a) Loss or dispersal of the *radioactive contents*;

(b) More than a 20% increase in the maximum ~~radiation level~~*dose equivalent rate* at any external surface of the *package*; except when the maximum dose equivalent rate on the external surface is below 10 μSv/h. In this case, there shall be no increase of more than 2 μSv/h in the maximum dose equivalent rate at any external surface of the package.

649. The *design* of a *package* intended for liquid *radioactive material* shall make provision for ullage to accommodate variations in the temperature of the contents, dynamic effects and filling dynamics.

650. A *Type A package* designed to contain liquid *radioactive material* shall, in addition:

(a) Be adequate to meet the conditions specified in para. 648(a) if the *package* is subjected to the tests specified in para. 725; and

(b) Either:

(i) Be provided with sufficient absorbent material to absorb twice the volume of the liquid contents. Such absorbent material must be suitably positioned so as to contact the liquid in the event of leakage; or

(ii) Be provided with a containment system composed of primary inner and secondary outer containment components designed to enclose the liquid contents completely and to ensure their retention within the secondary outer containment components, even if the primary inner components leak.

651. A *Type A package* designed for gases shall prevent loss or dispersal of the *radioactive contents* if the *package* were subjected to the tests specified in para. 725. A *Type A package* designed for tritium gas or for noble gases shall be excepted from this requirement.

## REQUIREMENTS FOR TYPE B(U) PACKAGES

652. *Type B(U) packages* shall be designed to meet the requirements specified in paras 607–618, the requirements specified in paras 619–621 if carried by air, and in paras 636–649, except as specified in para. 648(a), and, in addition, the requirements specified in paras 653–666.

653. A *package* shall be so designed that, under the ambient conditions specified in paras 656 and 657, heat generated within the *package* by the *radioactive contents* shall

not, under normal conditions of transport, as demonstrated by the tests in paras 719–724, adversely affect the *package* in such a way that it would fail to meet the applicable requirements for containment and shielding if left unattended for a period of one week. Particular attention shall be paid to the effects of heat that may cause one or more of the following:

- (a) Alteration of the arrangement, the geometrical form or the physical state of the *radioactive contents* or, if the *radioactive material* is enclosed in a can or receptacle (for example, clad fuel elements), cause the can, receptacle or *radioactive material* to deform or melt;
- (b) Lessening the efficiency of the *packaging* through differential thermal expansion, or cracking or melting of the radiation shielding material;
- (c) Acceleration of corrosion when combined with moisture.

654. A *package* shall be so designed that, under the ambient condition specified in para. 656 and in the absence of insolation, the temperature of the accessible surfaces of a *package* shall not exceed 50°C, unless the *package* is transported under *exclusive use*.

655. Except as required in para. 619 for a *package* transported by air, the maximum temperature of any surface readily accessible during transport of a *package* under *exclusive use* shall not exceed 85°C in the absence of insolation under the ambient condition specified in para. 656. Account may be taken of barriers or screens intended to give protection to persons without the need for the barriers or screens being subject to any test.

656. The ambient temperature shall be assumed to be 38°C.

657. The solar insolation conditions shall be assumed to be as specified in Table 12.

658. A *package* that includes thermal protection for the purpose of satisfying the requirements of the thermal test specified in para. 728 shall be so designed that such protection will remain effective if the *package* is subjected to the tests specified in paras 719–724 and 727(a) and 727(b) or 727(b) and 727(c), as appropriate. Any such protection on the exterior of the *package* shall not be rendered ineffective by ripping, cutting, skidding, abrading or rough handling.

659. A *package* shall be so designed that if it were subjected to:

- (a) The tests specified in paras 719–724, it would restrict the loss of *radioactive contents* to not more than  $10^{-6} A_2$  per hour.
- (b) The tests specified in paras 726, 727(b), 728 and 729 and either the test in:

—Para. 727(c), when the *package* has a mass not greater than 500 kg, an overall density not greater than 1000 kg/m<sup>3</sup> based on the external dimensions, and *radioactive contents* greater than 1000  $A_2$  not as *special form radioactive material*; or

—Para. 727(a), for all other *packages*.

- (i) It would retain sufficient shielding to ensure that the ~~radiation level~~dose equivalent rate 1 m from the surface of the *package* would not exceed 10 mSv/h with the maximum *radioactive contents* that the *package* is designed to contain.
- (ii) It would restrict the accumulated loss of *radioactive contents* in a period of one week to not more than 10  $A_2$  for krypton-85 and not more than  $A_2$  for all other radionuclides.

Where mixtures of different radionuclides are present, the provisions of paras 405–407 shall apply, except that for krypton-85 an effective  $A_2$  (i) value equal to 10  $A_2$  may be used. For case (a), the assessment shall take into account the external *contamination* limits of para. 508.

TABLE 12. INSOLATION DATA

Case	Form and location of surface	Insolation for 12 h per day (W/m <sup>2</sup> )
1	Flat surfaces transported horizontally — downward facing	0
2	Flat surfaces transported horizontally — upward facing	800
3	Surfaces transported vertically	200 <sup>a</sup>
4	Other downward facing (not horizontal) surfaces	200 <sup>a</sup>
5	All other surfaces	400 <sup>a</sup>

<sup>a</sup> Alternatively, a sine function may be used, with an absorption coefficient adopted and the effects of possible reflection from neighbouring objects neglected.

660. A *package* for *radioactive contents* with activity greater than  $10^5 A_2$  shall be so designed that if it were subjected to the enhanced water immersion test specified in para. 730, there would be no rupture of the *containment system*.

661. Compliance with the permitted activity release limits shall depend neither upon filters nor upon a mechanical cooling system.

662. A *package* shall not include a pressure relief system from the *containment system* that would allow the release of *radioactive material* to the environment under the conditions of the tests specified in paras 719–724 and 726–729.

663. A *package* shall be so designed that if it were at the *maximum normal operating pressure* and it were subjected to the tests specified in paras 719–724 and 726–729, the levels of strains in the *containment system* would not attain values that would adversely affect the *package* in such a way that it would fail to meet the applicable requirements.

664. A *package* shall not have a *maximum normal operating pressure* in excess of a gauge pressure of 700 kPa.

665. A *package* containing *low dispersible radioactive material* shall be so designed that any features added to the *low dispersible radioactive material* that are not part of it, or any internal components of the *packaging*, shall not adversely affect the performance of the *low dispersible radioactive material*.

666. A *package* shall be designed for an ambient temperature range of –40°C to +38°C.

#### REQUIREMENTS FOR TYPE B(M) PACKAGES

667. *Type B(M) packages* shall meet the requirements for *Type B(U) packages* specified in para. 652, except that for *packages* to be transported solely within a specified country or solely between specified countries, conditions other than those given in paras 639, 655–657 and 660–666 may be assumed with the *approval* of the *competent authorities* of these countries. Notwithstanding, the requirements for *Type B(U) packages* specified in paras 655 and 660–666 shall be met as far as practicable.

668. Intermittent venting of *Type B(M) packages* may be permitted during transport, provided that the operational controls for venting are acceptable to the relevant *competent authorities*.

#### REQUIREMENTS FOR TYPE C PACKAGES

669. *Type C packages* shall be designed to meet the requirements specified in paras 607–621 and 636–649, except as specified in para. 648(a), and the requirements specified in paras 653–657, 661–666 and 670–672.

670. A *package* shall be capable of meeting the assessment criteria prescribed for tests in paras 659(b) and 663 after burial in an environment defined by a thermal conductivity of 0.33 W/(m·K) and a temperature of 38°C in the steady state. Initial conditions for the assessment shall assume that any thermal insulation of the *package* remains intact, the *package* is at the *maximum normal operating pressure* and the ambient temperature is 38°C.

671. A *package* shall be so designed that if it were at the *maximum normal operating pressure* and subjected to:

(a) The tests specified in paras 719–724, it would restrict the loss of *radioactive contents* to not more than  $10^{-6} A_2$  per hour.

(i) It would retain sufficient shielding to ensure that the radiation-level-dose equivalent rate 1 m from the surface of the *package* would not exceed 10 mSv/h with the maximum *radioactive contents* that the *package* is designed to contain.

(ii) It would restrict the accumulated loss of *radioactive contents* in a period of one week to not more than  $10 A_2$  for krypton-85 and not more than  $A_2$  for all other radionuclides.

Where mixtures of different radionuclides are present, the provisions of paras 405–407 shall apply, except that for krypton-85 an effective  $A_2(i)$  value equal to  $10A_2$  may be used. For case (a), the assessment shall take into account the external *contamination* limits of para. 508.

672. A *package* shall be so designed that there will be no rupture of the *containment system* following performance of the enhanced water immersion test specified in para. 730.

#### REQUIREMENTS FOR PACKAGES CONTAINING FISSILE MATERIAL

673. *Fissile material* shall be transported so as to:

(a) Maintain subcriticality during routine, normal and accident conditions of transport; in particular, the following contingencies shall be considered:

(i) Leakage of water into or out of *packages*;

(ii) Loss of efficiency of built-in neutron absorbers or moderators;

(iii) Rearrangement of the contents either within the *package* or as a result of loss from the *package*;

(iv) Reduction of spaces within or between *packages*;

(v) *Packages* becoming immersed in water or buried in snow;

(vi) Temperature changes.

(b) Meet the requirements:

(i) Of para. 636 except for unpackaged material when specifically allowed by para. 417(e);

(ii) Prescribed elsewhere in these Regulations that pertain to the radioactive properties of the material;

(iii) Of para. 637 unless the material is excepted by para. 417;

(iv) Of paras 676–686, unless the material is excepted by para. 417, 674 or 675.

674. *Packages* containing *fissile material* that meets the requirements of para. 674(d) and one of the provisions of para. 674(a)–(c) are excepted from the requirements of paras 676–686.

(a) *Packages* containing *fissile material* in any form provided that:

(i) The smallest external dimension of the *package* is not less than 10 cm.

(ii) The *CSI* of the *package* is calculated using the following formula:

$$CSI = 50 \times 5 \times \{[\text{mass of uranium-235 in } \textit{package} \text{ (g)}]/Z + [\text{mass of other } \textit{fissile nuclides}^1 \text{ in } \textit{package} \text{ (g)}]/280\}$$

where the values of *Z* are taken from Table 13.

(iii) The *CSI* of any *package* does not exceed 10.

(b) *Packages* containing *fissile material* in any form provided that:

(i) The smallest external dimension of the *package* is not less than 30 cm.

(ii) The *package*, after being subjected to the tests specified in paras 719–724:

— Retains its *Fissile material* contents;

— Preserves the minimum overall outside dimensions of the *package* to at least 30 cm;

— Prevents the entry of a 10 cm cube.

(iii) The *CSI* of the *package* is calculated using the following formula:

$$CSI = 50 \times 2 \times \{[\text{mass of uranium-235 in } \textit{package} \text{ (g)}]/Z + [\text{mass of other } \textit{Fissile nuclides}^1 \text{ in } \textit{package} \text{ (g)}] / 280\}$$

where the values of *Z* are taken from Table 13.

(iv) The *CSI* of any *package* does not exceed 10.

(c) *Packages* containing *fissile material* in any form provided that:

(i) The smallest external dimension of the *package* is not less than 10 cm.

(ii) The *package*, after being subjected to the tests specified in paras 719–724:

- Retains its *Fissile material* contents;
- Preserves the minimum overall outside dimensions of the *package* to at least 10 cm;
- Prevents the entry of a 10 cm cube.

(iii) The *CSI* of the *package* is calculated using the following formula:

$$CSI = 50 \times 2 \times \{[\text{mass of uranium-235 in package (g)}]/450 + [\text{mass of other Fissile nuclides 1 in package (g)}]/280\}$$

(iv) The ~~maximum-total~~ mass of *fissile nuclides* in any *package* does not exceed 15 g.

TABLE 13. VALUES OF Z FOR CALCULATION OF CSI IN ACCORDANCE WITH PARA. 674

Enrichment <sup>a</sup>	Z
Uranium enriched up to 1.5%	2200
Uranium enriched up to 5%	850
Uranium enriched up to 10%	660
Uranium enriched up to 20%	580
Uranium enriched up to 100%	450

<sup>a</sup> If a *package* contains *uranium* with varying enrichments of uranium-235, then the value corresponding to the highest enrichment shall be used for Z.

(d) The total mass of beryllium, hydrogenous material enriched in deuterium, graphite and other allotropic forms of carbon in an individual *package* shall not be greater than the mass of *fissile nuclides* in the *package* except where their total concentration does not exceed 1 g in any 1000 g of material. Beryllium incorporated in copper alloys up to 4% by weight of the alloy does not need to be considered.

675. *Packages* containing not more than 1000 g of plutonium are excepted from the application of paras 676–686 provided that:

(a) Not more than 20% of the plutonium by mass is *fissile nuclides* .

(b) The *CSI* of the *package* is calculated using the following formula:

$$CSI = 50 \times 2 \times [\text{mass of plutonium (g)}/1000]$$

(c) If *uranium* is present with the plutonium, the mass of *uranium* shall be no more than 1% of the mass of the plutonium.

### **Contents specification for assessments of package designs containing fissile material**

676. Where the chemical or physical form, isotopic composition, mass or concentration, moderation ratio or density, or geometric configuration is not known, the assessments of paras 680–685 shall be performed assuming that each parameter that is not known has the value that gives the maximum neutron multiplication consistent with the known conditions and parameters in these assessments.

677. For irradiated nuclear fuel, the assessments of paras 680–685 shall be based on an isotopic composition demonstrated to provide either:

- (a) The maximum neutron multiplication during the irradiation history; or
- (b) A conservative estimate of the neutron multiplication for the *package* assessments. After irradiation but prior to *shipment*, a measurement shall be performed to confirm the conservatism of the isotopic composition.

### **Geometry and temperature requirements**

678. The *package*, after being subjected to the tests specified in paras 719–724, shall:

- (a) Preserve the minimum overall outside dimensions of the *package* to at least 10 cm;
- (b) Prevent the entry of a 10 cm cube.

679. The *package* shall be designed for an ambient temperature range of  $-40^{\circ}\text{C}$  to  $+38^{\circ}\text{C}$  unless the *competent authority* specifies otherwise in the certificate of *approval* for the *package design*.

### **Assessment of an individual package in isolation**

680. For a *package* in isolation, it shall be assumed that water can leak into or out of all void spaces of the *package*, including those within the *containment system*.

However, if the *design* incorporates special features to prevent such leakage of water into or out of certain void spaces, even as a result of error, absence of leakage may be assumed in respect of those void spaces. Special features shall include either of the following:

- (a) Multiple high standard water barriers, not less than two of which would remain watertight if the *package* were subject to the tests prescribed in para. 685(b), a high

degree of quality control in the manufacture, maintenance and repair of *packagings*, and tests to demonstrate the closure of each *package* before each *shipment*; or

(b) For *packages* containing uranium hexafluoride only, with a maximum *uranium* enrichment of 5 mass per cent uranium-235:

(i) *Packages* where, following the tests prescribed in para. 685(b), there is no physical contact between the valve or the plug and any other component of the *packaging* other than at its original point of attachment and where, in addition, following the test prescribed in para. 728, the valves and the plug remain leaktight;

(ii) A high degree of quality control in the manufacture, maintenance and repair of *packagings*, coupled with tests to demonstrate closure of each *package* before each *shipment*.

681. It shall be assumed that the *confinement system* is closely reflected by at least 20 cm of water or such greater reflection as may additionally be provided by the surrounding material of the *packaging*. However, when it can be demonstrated that the *confinement system* remains within the *packaging* following the tests prescribed in para. 685(b), close reflection of the *package* by at least 20 cm of water may be assumed in para. 682(c).

682. The *package* shall be subcritical under the conditions of paras 680 and 681 and with the *package* conditions that result in the maximum neutron multiplication consistent with:

(a) Routine conditions of transport (incident free);

(b) The tests specified in para. 684(b);

(c) The tests specified in para. 685(b).

683. For *packages* to be transported by air:

(a) The *package* shall be subcritical under conditions consistent with the *Type C package* tests specified in para. 734, assuming reflection by at least 20 cm of water but no water in-leakage.

(b) "In the assessment of para. 682, use of special features as specified in para. 680 is allowed provided that leakage of water into or out of the void spaces is prevented when the *package* is submitted to the *Type C package* tests specified in para. 734 followed by the water in-leakage test of para. 733."~~(b) In the assessment of para. 682, allowance shall not be made for special features of para. 680 unless, following the *Type C package* tests specified in para. 734 and, subsequently, the water in-~~

~~leakage test of para. 733, leakage of water into or out of the void spaces is prevented.~~

### **Assessment of package arrays under normal conditions of transport**

684. A number  $N$  shall be derived, such that five times  $N$  *packages* shall be subcritical for the arrangement and *package* conditions that provide the maximum neutron multiplication consistent with the following:

- (a) There shall not be anything between the *packages*, and the *package* arrangement shall be reflected on all sides by at least 20 cm of water.
- (b) The state of the *packages* shall be their assessed or demonstrated condition if they had been subjected to the tests specified in paras 719–724.

### **Assessment of package arrays under accident conditions of transport**

685. A number  $N$  shall be derived, such that two times  $N$  *packages* shall be subcritical for the arrangement and *package* conditions that provide the maximum neutron multiplication consistent with the following:

- (a) Hydrogenous moderation between the *packages* and the *package* arrangement reflected on all sides by at least 20 cm of water.
- (b) The tests specified in paras 719–724 followed by whichever of the following is the more limiting:
  - (i) The tests specified in para. 727(b) and either para. 727(c) for *packages* having a mass not greater than 500 kg and an overall density not greater than 1000 kg/m<sup>3</sup> based on the external dimensions or para. 727(a) for all other *packages*, followed by the test specified in para. 728 and completed by the tests specified in paras 731–733; or
  - (ii) The test specified in para. 729.
- (c) Where any part of the *fissile material* escapes from the *containment system* following the tests specified in para. 685(b), it shall be assumed that *fissile material* escapes from each *package* in the array and that all of the *fissile material* shall be arranged in the configuration and moderation that results in the maximum neutron multiplication with close reflection by at least 20 cm of water.

### **Determination of criticality safety index for packages**

686. The *CSI* for *packages* containing *fissile material* shall be obtained by dividing the number 50 by the smaller of the two values of  $N$  derived in paras 684 and 685 (i.e. *CSI*

=  $50/N$ ). The value of the *CSI* may be zero, provided that an unlimited number of *packages* are subcritical (i.e.  $N$  is effectively equal to infinity in both cases).

## Section VII

### TEST PROCEDURES

#### DEMONSTRATION OF COMPLIANCE

701. Demonstration of compliance with the performance standards required in Section VI shall be accomplished by any of the following methods listed below or by a combination thereof:

- (a) Performance of tests with specimens representing ~~LSA-III material, or special form radioactive material,~~ or *low dispersible radioactive material*, or with prototypes or samples of the *packaging*, where the contents of the specimen or the *packaging* for the tests shall simulate as closely as practicable the expected range of *radioactive contents* and the specimen or *packaging* to be tested shall be prepared as presented for transport.
- (b) Reference to previous satisfactory demonstrations of a sufficiently similar nature.
- (c) Performance of tests with models of appropriate scale, incorporating those features that are significant with respect to the item under investigation when engineering experience has shown the results of such tests to be suitable for *design* purposes. When a scale model is used, the need for adjusting certain test parameters, such as penetrator diameter or compressive load, shall be taken into account.
- (d) Calculation, or reasoned argument, when the calculation procedures and parameters are generally agreed to be reliable or conservative.

702. After the specimen, prototype or sample has been subjected to the tests, appropriate methods of assessment shall be used to ensure that the requirements of this section have been fulfilled in compliance with the performance and acceptance standards prescribed in Section VI.

#### LEACHING TEST FOR ~~LSA-III MATERIAL AND~~ LOW DISPERSIBLE RADIOACTIVE MATERIAL

703. A solid material sample representing the entire contents of the *package* shall be immersed for 7 days in water at ambient temperature. The volume of water to be used in the test shall be sufficient to ensure that at the end of the 7 day test period, the free volume of the unabsorbed and unreacted water remaining shall be at least 10% of the volume of the solid test sample itself. The water shall have an initial pH of 6–8 and a maximum conductivity of 1 mS/m at 20°C. The total activity of the free volume of water shall be measured following the 7 day immersion of the test sample.

#### TESTS FOR SPECIAL FORM RADIOACTIVE MATERIAL

## General

704. Specimens that comprise or simulate *special form radioactive material* shall be subjected to the impact test, the percussion test, the bending test and the heat test specified in paras 705–708. A different specimen may be used for each of the tests. Following each test, a leaching assessment or volumetric leakage test shall be performed on the specimen by a method no less sensitive than the methods given in para. 710 for indispersible solid material or in para. 711 for encapsulated material.

## Test methods

705. Impact test: The specimen shall drop onto the target from a height of 9 m. The target shall be as defined in para. 717.

706. Percussion test: The specimen shall be placed on a sheet of lead that is supported by a smooth solid surface and struck by the flat face of a mild steel bar so as to cause an impact equivalent to that resulting from a free drop of 1.4 kg through 1 m. The lower part of the bar shall be 25 mm in diameter with the edges rounded off to a radius of  $3.0 \pm 0.3$  mm. The lead, of hardness number 3.5–4.5 on the Vickers scale and not more than 25 mm thick, shall cover an area greater than that covered by the specimen. A fresh surface of lead shall be used for each impact. The bar shall strike the specimen so as to cause maximum damage.

707. Bending test: The test shall apply only to long, slender sources with both a minimum length of 10 cm and a length to minimum width ratio of not less than 10. The specimen shall be rigidly clamped in a horizontal position so that one half of its length protrudes from the face of the clamp. The orientation of the specimen shall be such that the specimen will suffer maximum damage when its free end is struck by the flat face of a steel bar. The bar shall strike the specimen so as to cause an impact equivalent to that resulting from a free vertical drop of 1.4 kg through 1 m. The lower part of the bar shall be 25 mm in diameter with the edges rounded off to a radius of  $3.0 \pm 0.3$  mm.

708. Heat test: The specimen shall be heated in air to a temperature of 800°C and held at that temperature for a period of 10 min and shall then be allowed to cool.

709. Specimens that comprise or simulate *radioactive material* enclosed in a sealed capsule may be excepted from:

- (a) The tests prescribed in paras 705 and 706, provided that the specimens are alternatively subjected to the impact test prescribed in the International Organization for Standardization document ISO 2919: Sealed Radioactive Sources — Classification [13]:

- (i) The Class 4 impact test if the mass of the *special form radioactive material* is less than 200 g;
  - (ii) The Class 5 impact test if the mass of the *special form radioactive material* is more than 200 g but less than 500 g.
- (b) The test prescribed in para. 708, provided the specimens are alternatively subjected to the Class 6 temperature test specified in ISO 2919 [13].

### **Leaching and volumetric leakage assessment methods**

710. For specimens that comprise or simulate indispersible solid material, a leaching assessment shall be performed as follows:

- (a) The specimen shall be immersed for 7 days in water at ambient temperature. The volume of water to be used in the test shall be sufficient to ensure that at the end of the 7 day test period the free volume of the unabsorbed and unreacted water remaining shall be at least 10% of the volume of the solid test sample itself. The water shall have an initial pH of 6–8 and a maximum conductivity of 1 mS/m at 20°C.
- (b) The water with the specimen shall then be heated to a temperature of  $50 \pm 5^\circ\text{C}$  and maintained at this temperature for 4 h.
- (c) The activity of the water shall then be determined.
- (d) The specimen shall then be kept for at least 7 days in still air at not less than 30°C and with a relative humidity of not less than 90%.
- (e) The specimen shall then be immersed in water of the same specification as that in (a) and the water with the specimen heated to  $50 \pm 5^\circ\text{C}$  and maintained at this temperature for 4 h.
- (f) The activity of the water shall then be determined.

711. For specimens that comprise or simulate *radioactive material* enclosed in a sealed capsule, either a leaching assessment or a volumetric leakage assessment shall be performed as follows:

- (a) The leaching assessment shall consist of the following steps:
  - (i) The specimen shall be immersed in water at ambient temperature. The water shall have an initial pH of 6–8 with a maximum conductivity of 1 mS/m at 20°C.

- (ii) The water and the specimen shall be heated to a temperature of  $50 \pm 5^\circ\text{C}$  and maintained at this temperature for 4 h.
  - (iii) The activity of the water shall then be determined.
  - (iv) The specimen shall then be kept for at least 7 days in still air at not less than  $30^\circ\text{C}$  and with a relative humidity of not less than 90%.
  - (v) The process in (i), (ii) and (iii) shall be repeated.
- (b) The alternative volumetric leakage assessment shall comprise any of the tests prescribed in the International Organization for Standardization document ISO 9978: Radiation Protection — Sealed Radioactive Sources — Leakage Test Methods [9] provided that they are acceptable to the *competent authority*.

## TESTS FOR LOW DISPERSIBLE RADIOACTIVE MATERIAL

712. A specimen that comprises or simulates *low dispersible radioactive material* shall be subjected to the enhanced thermal test specified in para. 736 and the impact test specified in para. 737. A different specimen may be used for each of the tests. Following each test, the specimen shall be subjected to the leach test specified in para. 703. After each test it shall be determined if the applicable requirements of para. 605 have been met.

## TESTS FOR PACKAGES

### **Preparation of a specimen for testing**

713. All specimens shall be inspected before testing in order to identify and record faults or damage, including the following:

- (a) Divergence from the *design*;
- (b) Defects in manufacture;
- (c) Corrosion or other deterioration;
- (d) Distortion of features.

714. The *containment system* of the *package* shall be clearly specified

715. The external features of the specimen shall be clearly identified so that reference may be made simply and clearly to any part of such a specimen.

### **Testing the integrity of the containment system and shielding and assessing criticality safety**

716. ~~After each test, or group of tests, or sequence of the applicable tests, as appropriate, specified in paras 718–737:~~

- (a) Faults and damage shall be identified and recorded.
- (b) It shall be determined whether the integrity of the *containment system* and shielding has been retained to the extent required in Section VI for the *package* under test.
- (c) For *packages* containing *fissile material*, it shall be determined whether the assumptions and conditions used in the assessments required by paras 673–686 for one or more *packages* are valid.

### **Target for drop tests**

717. The target for the drop test specified in paras 705, 722, 725(a), 727 and 735 shall be a flat, horizontal surface of such a character that any increase in its resistance to displacement or deformation upon impact by the specimen would not significantly increase damage to the specimen.

### **Test for packagings designed to contain uranium hexafluoride**

718. Specimens that comprise or simulate *packagings* designed to contain 0.1 kg or more of uranium hexafluoride shall be tested hydraulically at an internal pressure of at least 1.38 MPa, but when the test pressure is less than 2.76 MPa, the *design* shall require *multilateral approval*. For retesting *packagings*, any other equivalent non-destructive testing may be applied, subject to *multilateral approval*.

### **Tests for demonstrating ability to withstand normal conditions of transport**

719. The tests are the water spray test, the free drop test, the stacking test and the penetration test. Specimens of the *package* shall be subjected to the free drop test, the stacking test and the penetration test, preceded in each case by the water spray test. One specimen may be used for all the tests, provided that the requirements of para. 720 are fulfilled.

720. The time interval between the conclusion of the water spray test and the succeeding test shall be such that the water has soaked in to the maximum extent, without appreciable drying of the exterior of the specimen. In the absence of any evidence to the contrary, this interval shall be taken to be 2 h if the water spray is applied from four directions simultaneously. No time interval shall elapse, however, if the water spray is applied from each of the four directions consecutively.

721. Water spray test: The specimen shall be subjected to a water spray test that simulates exposure to rainfall of approximately 5 cm per hour for at least 1 h.

722. Free drop test: The specimen shall drop onto the target so as to suffer maximum damage in respect of the safety features to be tested:

- (a) The height of drop measured from the lowest point of the specimen to the upper surface of the target shall be not less than the distance specified in Table 14 for the applicable mass. The target shall be as defined in para. 717.
- (b) For rectangular fibreboard or wood *packages* not exceeding a mass of 50 kg, a separate specimen shall be subjected to a free drop onto each corner from a height of 0.3 m.
- (c) For cylindrical fibreboard *packages* not exceeding a mass of 100 kg, a separate specimen shall be subjected to a free drop onto each of the quarters of each rim from a height of 0.3 m.

723. Stacking test: Unless the shape of the *packaging* effectively prevents stacking, the specimen shall be subjected, for a period of 24 h, to a compressive load equal to the greater of the following:

- (a) The equivalent of 5 times the maximum weight of the *package*;
- (b) The equivalent of 13 kPa multiplied by the vertically projected area of the *package*.

The load shall be applied uniformly to two opposite sides of the specimen, one of which shall be the base on which the *package* would typically rest.

TABLE 14. FREE DROP DISTANCE FOR TESTING *PACKAGES* TO NORMAL CONDITIONS OF TRANSPORT

<i>Package</i> mass (kg)	Free drop distance (m)
$package\ mass < 5\ 000$	1.2
$5\ 000 \leq package\ mass < 10\ 000$	0.9
$10\ 000 \leq package\ mass < 15\ 000$	0.6
$15\ 000 \leq package\ mass$	0.3

724. Penetration test: The specimen shall be placed on a rigid, flat, horizontal surface that will not move significantly while the test is being carried out:

- (a) A bar 3.2 cm in diameter with a hemispherical end and a mass of 6 kg shall be dropped and directed to fall, with its longitudinal axis vertical, onto the centre of the weakest part of the specimen, so that, if it penetrates sufficiently far, it will hit the *containment system*. The bar shall not be significantly deformed by the test performance.

- (b) The height of drop of the bar measured from its lower end to the intended point of impact on the upper surface of the specimen shall be 1 m.

### **Additional tests for Type A packages designed for liquids and gases**

725. A specimen, or separate specimens, shall be subjected to each of the following tests unless it can be demonstrated that one test is more severe for the specimen in question than the other, in which case one specimen shall be subjected to the more severe test:

- (a) Free drop test: The specimen shall drop onto the target so as to suffer the maximum damage in respect of containment. The height of the drop measured from the lowest part of the specimen to the upper surface of the target shall be 9 m. The target shall be as defined in para. 717.
- (b) Penetration test: The specimen shall be subjected to the test specified in para. 724, except that the height of the drop shall be increased to 1.7 m from the 1 m specified in para. 724(b).

### **Tests for demonstrating ability to withstand accident conditions of transport**

726. The specimen shall be subjected to the cumulative effects of the tests specified in paras 727 and 728, in that order. Following these tests, either this specimen or a separate specimen shall be subjected to the effect(s) of the water immersion test(s), as specified in para. 729 and, if applicable, para. 730.

727. Mechanical test: The mechanical test consists of three different drop tests. Each specimen shall be subjected to the applicable drops, as specified in para. 659 or para. 685. The order in which the specimen is subjected to the drops shall be such that, on completion of the mechanical test, the specimen shall have suffered such damage as will lead to maximum damage in the thermal test that follows:

- (a) For drop I, the specimen shall drop onto the target so as to suffer maximum damage, and the height of the drop measured from the lowest point of the specimen to the upper surface of the target shall be 9 m. The target shall be as defined in para. 717.
- (b) For drop II, the specimen shall drop onto a bar rigidly mounted perpendicularly on the target so as to suffer maximum damage. The height of the drop measured from the intended point of impact of the specimen to the upper surface of the bar shall be 1 m. The bar shall be of solid mild steel of circular section,  $15.0 \pm 0.5$  cm in diameter and 20 cm long, unless a longer bar would cause greater damage, in which case a bar of sufficient length to cause maximum damage shall be used. The upper

end of the bar shall be flat and horizontal with its edge rounded off to a radius of not more than 6 mm. The target on which the bar is mounted shall be as described in para. 717.

- (c) For drop III, the specimen shall be subjected to a dynamic crush test by positioning the specimen on the target so as to suffer maximum damage by the drop of a 500 kg mass from 9 m onto the specimen. The mass shall consist of a solid mild steel plate 1 m × 1 m and shall fall in a horizontal attitude. The lower face of the steel plate shall have its edges and corners rounded off to a radius of not more than 6 mm. The height of the drop shall be measured from the underside of the plate to the highest point of the specimen. The target on which the specimen rests shall be as defined in para. 717.

728. Thermal test: The specimen shall be in thermal equilibrium under conditions of an ambient temperature of 38°C, subject to the solar insolation conditions specified in Table 12 and subject to the *design* maximum rate of internal heat generation within the *package* from the *radioactive contents*. Alternatively, any of these parameters are allowed to have different values prior to, and during, the test, provided due account is taken of them in the subsequent assessment of *package* response. The thermal test shall then consist of (a) followed by (b).

- (a) Exposure of a specimen for a period of 30 min to a thermal environment that provides a heat flux at least equivalent to that of a hydrocarbon fuel–air fire in sufficiently quiescent ambient conditions to give a minimum average flame emissivity coefficient of 0.9 and an average temperature of at least 800°C, fully engulfing the specimen, with a surface absorptivity coefficient of 0.8 or that value that the *package* may be demonstrated to possess if exposed to the fire specified.
- (b) Exposure of the specimen to an ambient temperature of 38°C, subject to the solar insolation conditions specified in Table 12 and subject to the *design* maximum rate of internal heat generation within the *package* by the *radioactive contents* for a sufficient period to ensure that temperatures in the specimen are everywhere decreasing and/or are approaching initial steady state conditions. Alternatively, any of these parameters are allowed to have different values following cessation of heating, provided due account is taken of them in the subsequent assessment of *package* response. During and following the test, the specimen shall not be artificially cooled and any combustion of materials of the specimen shall be permitted to proceed naturally.

729. Water immersion test: The specimen shall be immersed under a head of water of at least 15 m for a period of not less than 8 h in the attitude that will lead to maximum

damage. For demonstration purposes, an external gauge pressure of at least 150 kPa shall be considered to meet these conditions.

**Enhanced water immersion test for Type B(U) and Type B(M) packages containing more than  $10^5$  A<sub>2</sub> and Type C packages**

730. Enhanced water immersion test: The specimen shall be immersed under a head of water of at least 200 m for a period of not less than 1 h. For demonstration purposes, an external gauge pressure of at least 2 MPa shall be considered to meet these conditions.

**Water leakage test for packages containing fissile material**

731. *Packages* for which water in-leakage or out-leakage to the extent that results in greatest reactivity has been assumed for purposes of assessment under paras 680–685 shall be excepted from the test.

732. Before the specimen is subjected to the water leakage test specified below, it shall be subjected to the tests in para. 727(b) and either para. 727(a) or 727(c), as required by para. 685 and the test specified in para. 728.

733. The specimen shall be immersed under a head of water of at least 0.9 m for a period of not less than 8 h and in the attitude for which maximum leakage is expected.

**Tests for Type C packages**

734. Specimens shall be subjected to the effects of the following test sequences:

(a) The tests specified in paras 727(a), 727(c), 735 and 736, in this order;

(b) The test specified in para. 737.

Separate specimens are allowed to be used for the sequence in (a) and for (b).

735. Puncture–tearing test: The specimen shall be subjected to the damaging effects of a vertical solid probe made of mild steel. The orientation of the *package* specimen and the impact point on the *package* surface shall be such as to cause maximum damage at the conclusion of the test sequence specified in para. 734(a):

(a) The specimen, representing a *package* having a mass of less than 250 kg, shall be placed on a target and subjected to a probe having a mass of 250 kg falling from a height of 3 m above the intended impact point. For this test the probe shall be a 20 cm diameter cylindrical bar with the striking end forming the frustum of a right circular cone with the following dimensions: 30 cm height and 2.5 cm diameter at the top with its edge rounded off to a radius of not more than 6 mm. The target on which the specimen is placed shall be as specified in para. 717.

(b) For *packages* having a mass of 250 kg or more, the base of the probe shall be placed on a target and the specimen dropped onto the probe. The height of the drop, measured from the point of impact with the specimen to the upper surface of the probe, shall be 3 m. The probe for this test shall have the same properties and dimensions as specified in (a), except that the length and mass of the probe shall be such as to cause maximum damage to the specimen. The target on which the base of the probe is placed shall be as specified in para. 717.

736. Enhanced thermal test: The conditions for this test shall be as specified in para. 728, except that the exposure to the thermal environment shall be for a period of 60 min.

737. Impact test: The specimen shall be subject to an impact on a target at a velocity of not less than 90 m/s, at such an orientation as to suffer maximum damage. The target shall be as defined in para. 717, except that the target surface may be at any orientation as long as the surface is normal to the specimen path.

## Section VIII

### APPROVAL AND ADMINISTRATIVE REQUIREMENTS<sup>2</sup>

~~<sup>2</sup>Although this publication is identified as a new edition, there are no changes that affect the administrative and approval requirements in respect of radioactive material and packages approved under the previous editions, amendments or revisions since the 1996 Edition.~~

#### GENERAL

801. For *package designs* where it is not required that a *competent authority* issue a certificate of *approval*, the *consignor* shall, on request, make available for inspection by the relevant *competent authority*, documentary evidence of the compliance of the *package design* with all the applicable requirements.

802. *Competent authority approval* shall be required for the following:

(a) *Designs* for:

- (i) *Special form radioactive material* (see paras 803, 804 and 823);
- (ii) *Low dispersible radioactive material* (see paras 803 and 804);
- (iii) *Fissile material* excepted under para. 417(f) (see paras 805 and 806);
- (iv) *Packages* containing 0.1 kg or more of uranium hexafluoride (see para. 807);
- (v) *Packages* containing *fissile material*, unless excepted by para. 417, 674 or 675 (see paras 814–816 and 820);
- (vi) *Type B(U) packages* and *Type B(M) packages* (see paras 808–813 and 820);
- (vii) *Type C packages* (see paras 808–810).

(b) *Special arrangements* (see paras 829–831).

(c) Certain *shipments* (see paras 825–828[to check new #]).

(d) *Radiation protection programme* for special use *vessels* (see para. 576(a)).

(e) Calculation of radionuclide values that are not listed in Table 2 (see para. 403(a)).

(f) Calculation of alternative activity limits for an exempt *consignment* of instruments or articles (see para. 403(b)).

The certificates of *approval* for the *package design* and the *Shipment* may be combined into a single certificate.

## APPROVAL OF SPECIAL FORM RADIOACTIVE MATERIAL AND LOW DISPERSIBLE RADIOACTIVE MATERIAL

803. The *design* for *special form radioactive material* shall require *unilateral approval*. The *design* for *low dispersible radioactive material* shall require *multilateral approval*. In both cases, an application for *approval* shall include:

- (a) A detailed description of the *radioactive material* or, if a capsule, the contents; particular reference shall be made to both physical and chemical states.
- (b) A detailed statement of the *design* of any capsule to be used.
- (c) A statement of the tests that have been carried out and their results, or evidence based on calculative methods, to show that the *radioactive material* is capable of meeting the performance standards, or other evidence that the *special form radioactive material* or *low dispersible radioactive material* meets the applicable requirements of these Regulations.
- (d) A specification of the applicable *management system*, as required in para. 306.
- (e) Any proposed pre-*Shipment* actions for use in the *consignment* of *special form radioactive material* or *low dispersible radioactive material*.

804. The *competent authority* shall establish a certificate of *approval* stating that the approved *design* meets the requirements for *special form radioactive material* or *low dispersible radioactive material* and shall attribute to that *design* an identification mark.

## APPROVAL OF MATERIAL EXCEPTED FROM FISSILE CLASSIFICATION

805. The *design* for a *fissile material* excepted from “FISSILE” classification in accordance with Table 1, under para. 417(f) shall require *multilateral approval*. An application for *approval* shall include:

- (a) A detailed description of the material; particular reference shall be made to both physical and chemical states.
- (b) A statement of the tests that have been carried out and their results, or evidence based on calculative methods, to show that the material is capable of meeting the requirements specified in para. 606.
- (c) A specification of the applicable *management system* as required in para. 306.

(d) A statement of specific actions to be taken prior to *Shipment*.

806. The *competent authority* shall establish a certificate of *approval* stating that the approved material meets the requirements for *fissile material* excepted by the *competent authority* in accordance with para. 606 and shall attribute to that *design* an identification mark.

## APPROVAL OF PACKAGE DESIGNS

### **Approval of package designs to contain uranium hexafluoride**

807. The *approval* of *designs* for *packages* containing 0.1 kg or more of uranium hexafluoride requires that:

- (a) Each *design* that meets the requirements of para. 634 shall require *multilateral approval*.
- (b) Each *design* that meets the requirements of paras 631–633 shall require *unilateral approval* by the *competent authority* of the country of origin of the *design*, unless *multilateral approval* is otherwise required by these Regulations.
- (c) The application for *approval* shall include all information necessary to satisfy the *competent authority* that the *design* meets the requirements of para. 631 and a specification of the applicable *management system*, as required in para. 306.
- (d) The *competent authority* shall establish a certificate of *approval* stating that the approved *design* meets the requirements of para. 631 and shall attribute to that *design* an identification mark.

### **Approval of Type B(U) and Type C package designs**

808. Each *Type B(U)* and *Type C package design* shall require *unilateral approval*, except that:

- (a) A *package design* for *fissile material*, which is also subject to paras 814–816, shall require *multilateral approval*.
- (b) A *Type B(U) package design* for *low dispersible radioactive material* shall require *multilateral approval*.

809. An application for *approval* shall include:

- (a) A detailed description of the proposed *radioactive contents* with reference to their physical and chemical states and the nature of the radiation emitted;

- (b) A detailed statement of the *design*, including complete engineering drawings and schedules of materials and methods of manufacture;
- (c) A statement of the tests that have been carried out and their results, or evidence based on calculative methods or other evidence that the *design* is adequate to meet the applicable requirements;
- (d) The proposed operating and maintenance instructions for the use of the *packaging*;
- (e) If the *package* is designed to have a *maximum normal operating pressure* in excess of 100 kPa gauge, a specification of the materials of manufacture of the *containment system*, the samples to be taken and the tests to be made;

(e)bis If the *package* is to be used for *shipment* after storage, the applicant shall state and justify the consideration of ageing mechanisms on the safety analysis and within the proposed operating and maintenance instructions.

- (f) Where the proposed *radioactive contents* are irradiated nuclear fuel, the applicant shall state and justify any assumption in the safety analysis relating to the characteristics of the fuel and describe any pre-shipment measurement required by para. 677(b);
- (g) Any special stowage provisions necessary to ensure the safe dissipation of heat from the *package* considering the various modes of transport to be used and the type of *conveyance* or *freight container*;
- (h) A reproducible illustration, not larger than 21 cm × 30 cm, showing the make-up of the *package*;
- (i) A specification of the applicable *management system* as required in para. 306.

(j) For *packages* which are used for *shipment* after storage, a gap analysis programme shall be provided. The gap analysis programme shall describe a systematic procedure to consider changes of regulations, changes in technical knowledge and changes of the state of the *package design* during storage.

810. The *competent authority* shall establish a certificate of *approval* stating that the approved *design* meets the requirements for *Type B(U)* or *Type C packages* and shall attribute to that *design* an identification mark.

### **Approval of Type B(M) package designs**

811. Each *Type B(M) package design*, including those for *fissile material* which are also subject to paras 814–816 and those for *low dispersible radioactive material*, shall require *multilateral approval*.

812. An application for *approval* of a *Type B(M) package design* shall include, in addition to the information required in para. 809 for *Type B(U) packages*:

- (a) A list of the requirements specified in paras 639, 655–657 and 660–666 with which the *package* does not conform;
- (b) Any proposed supplementary operational controls to be applied during transport not regularly provided for in these Regulations, but which are necessary to ensure the safety of the *package* or to compensate for the deficiencies listed in (a);
- (c) A statement relative to any restrictions on the mode of transport and to any special loading, carriage, unloading or handling procedures;
- (d) A statement of the range of ambient conditions (temperature, solar insolation) that are expected to be encountered during transport and which have been taken into account in the *design*.

813. The *competent authority* shall establish a certificate of *approval* stating that the approved *design* meets the applicable requirements for *Type B(M) packages* and shall attribute to that *design* an identification mark.

#### **Approval of package designs to contain fissile material**

814. Each *package design* for *fissile material* that is not excepted by any of the paras 417(a)–(f), 674 and 675 shall require *multilateral approval*.

815. An application for *approval* shall include all information necessary to satisfy the *competent authority* that the *design* meets the requirements of para. 673 and a specification of the applicable *management system*, as required in para. 306.

816. The *competent authority* shall establish a certificate of *approval* stating that the approved *design* meets the requirements of para. 673 and shall attribute to that *design* an identification mark.

#### **APPROVAL OF ALTERNATIVE ACTIVITY LIMITS FOR AN EXEMPT CONSIGNMENT OF INSTRUMENTS OR ARTICLES**

817. Alternative activity limits for an exempt *consignment* of instruments or articles in accordance with para. 403(b) shall require *multilateral approval*. An application for *approval* shall include:

- (a) An identification and detailed description of the instrument or article, its intended uses and the radionuclide(s) incorporated;
- (b) The maximum activity of the radionuclide(s) in the instrument or article;

- (c) Maximum external ~~radiation level~~dose equivalent rates arising from the instrument or article;
- (d) The chemical and physical forms of the radionuclide(s) contained in the instrument or article;
- (e) Details of the construction and *design* of the instrument or article, particularly as related to the *containment* and shielding of the radionuclide in routine, normal and accident conditions of transport;
- (f) The applicable *management system*, including the quality testing and verification procedures to be applied to radioactive sources, components and finished products to ensure that the maximum specified activity of *radioactive material* or the maximum ~~radiation level~~dose equivalent rates specified for the instrument or article are not exceeded, and that the instruments or articles are constructed according to the *design* specifications;
- (g) The maximum number of instruments or articles expected to be shipped per *consignment* and annually;
- (h) Dose assessments in accordance with the principles and methodologies set out in the BSS [2], including individual doses to transport workers and members of the public and, if appropriate, collective doses arising from routine, normal and accident conditions of transport, based on representative transport scenarios that the *consignments* are subject to.

818. The *competent authority* shall establish a certificate of *approval* stating that the approved alternative activity limit for an exempt *consignment* of instruments or articles meets the requirements of para. 403(b) and shall attribute to that certificate an identification mark.

#### TRANSITIONAL ARRANGEMENTS

##### **Packages not requiring competent authority approval of design under the 1985, ~~and 1985 (As Amended 1990), 1996 Edition, 1996 Edition (Revised), 1996 (As amended 2003), 2005, 2009 and 2012 Editions of these Regulations~~**

819. *Packages* not requiring *competent authority approval of design (excepted packages, Type IP-1, Type IP-2, Type IP-3 and Type A packages)* shall meet this Edition of these Regulations in full, except that:

~~A.~~P*ackages* that meet the requirements of the 1985 or 1985 (As Amended 1990) Editions of these Regulations:

- (a) May continue in transport provided that they were prepared for transport prior to 31 December 2003 and are subject to the requirements of para. 822, if applicable; or
- (b) May continue to be used, provided that all the following conditions are met:
  - (i) They were not designed to contain uranium hexafluoride.
  - (ii) The applicable requirements of para. 306 of this Edition of these Regulations are applied.
  - (iii) The activity limits and classification in Section IV of this Edition of these Regulations are applied.
  - (iv) The requirements and controls for transport in Section V of this Edition of these Regulations are applied.

B. Packages that meet the requirements of the 1996 Edition, 1996 Edition (Revised), 1996 (As amended 2003), 2005, 2009 or 2012 Editions of these Regulations:

(a) May continue in transport provided that they were prepared for transport prior to 31 December 2025 and are subject to the requirements of para. 822, if applicable; or

(b) May continue to be used, provided that all the following conditions are met:

- (i) The applicable requirements of para. 306 of this Edition of these Regulations are applied;
- (ii) The activity limits and classification in Section IV of this Edition of these Regulations are applied;
- (iii) The requirements and controls for transport in Section V of this Edition of these Regulations are applied; and
- (iv) The packaging was not manufactured or modified after 31 December 2025.

**Package designs approved under the 1973, 1973 (As Amended), 1985, and 1985 (As Amended 1990), 1996 Edition, 1996 Edition (Revised), 1996 (As amended 2003), 2005, 2009 and 2012 Editions of these Regulations**

820. Packages requiring *competent authority approval* of the design shall meet this Edition of these Regulations in full ~~unless the following conditions are met~~ except that:

- (a) ~~The p~~Packagings that were manufactured to a package design approved by the competent authority under the provisions of ~~the 1973 or 1973 (As Amended) or the 1985 or 1985 (As Amended 1990) Editions of these Regulations~~ may continue to be used provided that all of the following conditions are met:-

- (b) The package design is subject to multilateral approval.
- (eii) The applicable requirements of para. 306 of this Edition of these Regulations are applied.
- (eiii) The activity limits and classification in Section IV of this Edition of these Regulations are applied.
- (eiv) The requirements and controls for transport in Section V of this Edition of these Regulations are applied.
- (ev) For a package containing fissile material and transported by air, the requirement of para. 683 is met.

~~(g) For packages that meet the requirements of the 1973 or 1973 (As Amended) Editions of these Regulations:~~

~~(i) The packages retain sufficient shielding to ensure that the radiation level at 1 m from the surface of the package would not exceed 10 mSv/h in the accident conditions of transport defined in the 1973 Revised or 1973 Revised (As Amended) Editions of these Regulations with the maximum radioactive contents which the package is authorized to contain.~~

~~(ii) The packages do not utilize continuous venting.~~

~~(iii) A serial number in accordance with the provision of para. 535 is assigned to and marked on the outside of each packaging.~~

(b) Packagings that were manufactured to a package design approved by the competent authority under the provisions of the 1996 Edition, 1996 Edition (Revised), 1996 (As amended 2003), 2005, 2009 and 2012 Editions of these Regulations may continue to be used provided that all of the following conditions are met:

- (i) The package design is subject to multilateral approval after 31 December 2025.
- (ii) The applicable requirements of para. 306 of this Edition of the Regulations are applied.
- (iii) The activity limits and material restrictions of Section IV of this Edition of these Regulations are applied.
- (iv) The requirements and controls for transport in Section V of this Edition of these Regulations are applied.

821. No new manufacture of *packagings* to a *package design* meeting the provisions of the ~~1973, 1973 (As Amended),~~ 1985 and 1985 (As Amended 1990) Editions of these Regulations shall be permitted to commence.

821bis. No new manufacture of *packagings* to a *package design* meeting the provisions of the 1996 Edition, 1996 Edition (Revised), 1996 (As amended 2003), 2005, 2009 and 2012 Editions of these Regulations shall be permitted to commence after 31 December 2028.

### **Packages excepted from the requirements for fissile material under the 2009 Edition of these Regulations**

822. *Packages* containing *fissile material* that is excepted from classification as “FISSILE” according to para. 417(a)(i) or (iii) of the 2009 Edition of these Regulations prepared for transport before 31 December 2014 may continue in transport and may continue to be classified as non-fissile or fissile-excepted except that the *consignment* limits in Table 4 of the 2009 Edition of these Regulations shall apply to the *conveyance*. The *consignment* shall be transported under *exclusive use*.

### **Special form radioactive material approved under the ~~1973, 1973 (As Amended), 1985, and 1985 (As Amended 1990),~~ 1996 Edition, 1996 Edition (Revised), 1996 (As amended 2003), 2005, 2009 and 2012 Editions of these Regulations**

823. *Special form radioactive material* manufactured to a *design* that had received *unilateral approval* by the *competent authority* under the ~~1973, 1973 (As Amended), 1985, or 1985 (As Amended 1990),~~ 1996 Edition, 1996 Edition (Revised), 1996 (As amended 2003), 2005, 2009 and 2012 -Editions of these Regulations may continue to be used when in compliance with the mandatory *management system* in accordance with the applicable requirements of para. 306. ~~There shall be No~~ new manufacture of ~~such~~ *special form radioactive material* to a design that had received unilateral approval by the competent authority under the 1985 or 1985 (As Amended 1990) shall be permitted to commence. No new manufacture of special form radioactive material to a design that had received unilateral approval by the competent authority under the 1996 Edition, 1996 Edition (Revised), 1996 (As amended 2003), 2005, 2009 and 2012 shall be permitted to commence after 31 December 2025.

### **NOTIFICATION AND REGISTRATION OF SERIAL NUMBERS**

824. The *competent authority* shall be informed of the serial number of each *packaging* manufactured to a *design* approved under paras 808, 811, 814 and 820.

### **APPROVAL OF SHIPMENTS**

825. *Multilateral approval* shall be required for:

- (a) The *shipment* of *Type B(M) packages* not conforming with the requirements of para. 639 or designed to allow controlled intermittent venting.
- (b) The *shipment* of *Type B(M) packages* containing *radioactive material* with an activity greater than 3000  $A_1$  or 3000  $A_2$ , as appropriate, or 1000 TBq, whichever is the lower.
- (c) The *shipment* of *packages* containing *fissile material* if the sum of the *CSIs* of the *packages* in a single *freight container* or in a single *conveyance* exceeds 50. Excluded from this requirement shall be *shipments* by seagoing *vessels*, if the sum of the *CSIs* does not exceed 50 for any hold, compartment or defined deck area and the distance of 6 m between groups of *packages* or *overpacks*, as required in Table 11, is met.
- (d) *Radiation protection programmes* for *shipments* by special use *vessels* in accordance with para. 576(a).

(e) The *shipment* of *SCO-III*.

826. A *competent authority* may authorize transport through or into its country without *shipment approval*, by a specific provision in its *design approval*.

827. An application for *approval of shipment* shall include:

- (a) The period of time, related to the *shipment*, for which the *approval* is sought;
- (b) The actual *radioactive contents*, the expected modes of transport, the type of *conveyance* and the probable or proposed route;
- (c) The details of how the precautions and administrative or operational controls, referred to in the certificates of approval for the package design, if applicable, issued under paras 810, 813 and 816, are to be put into effect.

827 bis. An application for *approval of SCO-III shipments* shall include:

(a) A statement of the respects in which, and of the reasons why, the *consignment* is considered a *SCO-III*.

(b) Justification for choosing *SCO-III* by demonstrating that:

(i) no suitable *packaging* currently exists;

(ii) *designing and/or constructing a packaging* or *segmenting the object* is not practically, technically or economically feasible;

(iii) no other viable alternative exists;

(iv) the advantages and level of overall level of safety and security to conducting the transport as *SCO-III* exceed any possible disadvantages or risks, respectively.

(c) A detailed description of the proposed *radioactive contents* with reference to their physical and chemical states and the nature of the radiation emitted;

(d) A detailed statement of the design of the *SCO-III*, including complete engineering drawings and schedules of materials and methods of manufacture;

(e) All information necessary to satisfy the *competent authority* that the requirements of para. 520(e) and the requirements of paras. 413(c)(iv) and 522, if applicable, are satisfied;

(f) A transport plan covering all activities associated with the *shipment*, including radiation protection, emergency response, and any special precautions or special administrative or operational controls which are to be employed during transit;

(g) A specification of the applicable *management system* as required in para. 306.

828. Upon approval of the *shipment*, the *competent authority* shall issue a *certificate of approval*.

#### APPROVAL OF SHIPMENTS UNDER SPECIAL ARRANGEMENT

829. Each *consignment* transported under *special arrangement* shall require *multilateral approval*.

830. An application for *approval* of *shipments* under *special arrangement* shall include all the information necessary to satisfy the *competent authority* that the overall level of safety in transport is at least equivalent to that which would be provided if all the applicable requirements of these Regulations had been met. The application shall also include:

(a) A statement of the respects in which, and of the reasons why, the *shipment* cannot be made in full accordance with the applicable requirements;

(b) A statement of any special precautions or special administrative or operational controls that are to be employed during transport to compensate for the failure to meet the applicable requirements.

831. Upon *approval* of *shipments* under *special arrangement*, the *competent authority* shall issue a *certificate of approval*.

## COMPETENT AUTHORITY CERTIFICATES OF APPROVAL

### Competent authority identification marks

832. Each certificate of *approval* issued by a *competent authority* shall be assigned an identification mark. The mark shall be of the following generalized type:

VRI/Number/*Type Code*

- (a) Except as provided in para. 833(b), VRI represents the international *vehicle* registration identification code of the country issuing the certificate.
- (b) The number shall be assigned by the *competent authority* and shall be unique and specific with regard to the particular *design*, *shipment* or alternative activity limit for exempt *consignment*. The identification mark of the *approval* of *shipment* shall be clearly related to the identification mark of the *approval* of *design*.
- (c) The following type codes shall be used in the order listed to indicate the types of certificate of *approval* issued:

AF	<i>Type A package design for fissile material</i>
B(U)	<i>Type B(U) package design (B(U)F if for fissile material)</i>
B(M)	<i>Type B(M) package design (B(M)F if for fissile material)</i>
C	<i>Type C package design (CF if for fissile material)</i>
IF	<i>Industrial package design for fissile material</i>
S	<i>Special form radioactive material</i>
LD	<i>Low dispersible radioactive material</i>
FE	<i>Fissile material complying with the requirements of para. 606</i>
T	<i>Shipment</i>
X	<i>Special arrangement</i>
AL	Alternative activity limits for an exempt <i>consignment</i> of instruments or articles

In the case of *package designs* for non-fissile or fissile-excepted uranium hexafluoride, where none of the above codes apply, the following type codes shall be used:

- H(U) Unilateral approval
- H(M) Multilateral approval.

~~(d) For certificates of approval of package design and special form radioactive material, other than those issued under the provisions of paras 820-823, and for certificates of approval of low dispersible radioactive material, the symbol “96” shall be added to the type code.~~

833. These identification marks shall be applied as follows:

- (a) Each certificate and each package shall bear the appropriate identification mark, comprising the symbols prescribed in para. 832(a)-(cd), except that, for packages, only the applicable design type codes ~~including, if applicable, the symbol “96”~~ shall appear following the second stroke, that is, the “T” or “X” shall not appear in the identification marking on the package. Where the approval of design and the approval of shipment are combined, the applicable type codes do not need to be repeated. For example:

A/132/B(M)F-96: A *Type B(M) package design* approved for *fissile material*, requiring *multilateral approval*, for which the *competent authority* of Austria has assigned the *design* number 132 (to be marked both on the *package* and on the certificate of *approval* for the *package design*)

A/132/B(M)F-96T: The approval of shipment issued for a package bearing the identification mark elaborated above (to be marked on the certificate only)

A/137/X: An approval of special arrangement issued by the competent authority of Austria, to which the number 137 has been assigned (to be marked on the certificate only)

A/139/IF-96: An industrial package design for fissile material approved by the competent authority of Austria, to which package design number 139 has been assigned (to be marked both on the package and on the certificate of approval for the package design) A/145/H(U)-96: A package design for fissile-excepted uranium hexafluoride approved by the competent authority of Austria, to which package design number 145 has been assigned (to be marked both on the package and on the certificate of approval for the package design)

- (b) Where *multilateral approval* is effected by validation in accordance with para. 840, only the identification mark issued by the country of origin of the *design* or *shipment* shall be used. Where *multilateral approval* is effected by issue of certificates by successive countries, each certificate shall bear the appropriate identification mark and the *package* whose *design* was so approved shall bear all appropriate identification marks.

For example:

A/132/B(M)F-96

CH/28/B(M)F-96

would be the identification mark of a *package* that was originally approved by Austria and was subsequently approved, by separate certificate, by Switzerland. Additional identification marks would be tabulated in a similar manner on the *package*.

- (c) The revision of a certificate shall be indicated by a parenthetical expression following the identification mark on the certificate. For example, A/132/B(M)F-96(Rev.2) would indicate revision 2 of the Austrian certificate of *approval* for the *package design*; or A/132/B(M)F-96(Rev.0) would indicate the original issuance of the Austrian certificate of *approval* for the *package design*. For original issuances, the parenthetical entry is optional and other words such as “original issuance” may also be used in place of “Rev.0”. Certificate revision numbers may only be issued by the country issuing the original certificate of *approval*.
- (d) Additional symbols (as may be necessitated by national requirements) may be added in brackets to the end of the identification mark, for example, A/132/B(M)F-96(SP503).
- (e) It is not necessary to alter the identification mark on the *packaging* each time that a revision to the design certificate is made. Such re-marking shall be required only in those cases where the revision to the package design certificate involves a change in the letter type codes for the *package design* following the second stroke.

## CONTENTS OF CERTIFICATES OF APPROVAL

### **Certificates of approval for special form radioactive material and low dispersible radioactive material**

834. Each certificate of *approval* issued by a *competent authority* for *special form radioactive material* or *low dispersible radioactive material* shall include the following information:

- (a) Type of certificate;
- (b) The *competent authority* identification mark;
- (c) The issue date and an expiry date;
- (d) List of applicable national and international regulations, including the edition of the IAEA Regulations for the Safe Transport of Radioactive Material under which the

*special form radioactive material* or *low dispersible radioactive material* is approved;

- (e) The identification of the *special form radioactive material* or *low dispersible radioactive material*;
- (f) A description of the *special form radioactive material* or *low dispersible radioactive material*;
- (g) *Design* specifications for the *special form radioactive material* or *low dispersible radioactive material*, which may include references to drawings;
- (h) A specification of the *radioactive contents* that includes the activities involved and which may include the physical and chemical forms;
- (i) A specification of the applicable *management system*, as required in para. 306;
- (j) Reference to information provided by the applicant relating to specific actions to be taken prior to *shipment*;
- (k) If deemed appropriate by the *competent authority*, reference to the identity of the applicant;
- (l) Signature and identification of the certifying official.

#### **Certificates of approval for material excepted from fissile classification**

835. Each certificate of *approval* issued by a *competent authority* for material excepted from classification as “FISSILE” shall include the following information:

- (a) Type of certificate;
- (b) The *competent authority* identification mark;
- (c) The issue date and an expiry date;
- (d) List of applicable national and international regulations, including the edition of the IAEA Regulations for the Safe Transport of Radioactive Material under which the exception is approved;
- (e) A description of the excepted material;
- (f) Limiting specifications for the excepted material;
- (g) A specification of the applicable *management system*, as required in para. 306;

- (h) Reference to information provided by the applicant relating to specific actions to be taken prior to *shipment*;
- (i) If deemed appropriate by the *competent authority*, reference to the identity of the applicant;
- (j) Signature and identification of the certifying official;
- (k) Reference to documentation that demonstrates compliance with para. 606.

### **Certificates of approval for special arrangement**

836. Each certificate of *approval* issued by a *competent authority* for a *special arrangement* shall include the following information:

- (a) Type of certificate.
- (b) The *competent authority* identification mark.
- (c) The issue date and an expiry date.
- (d) Mode(s) of transport.
- (e) Any restrictions on the modes of transport, type of *conveyance*, *freight container* and any necessary routing instructions.
- (f) List of applicable national and international regulations, including the edition of the IAEA Regulations for the Safe Transport of Radioactive Material under which the *special arrangement* is approved.
- (g) The following statement: “This certificate does not relieve the *consignor* from compliance with any requirement of the government of any country *through or into* which the *package* will be transported”.
- (h) References to certificates for alternative *Radioactive contents*, other *competent authority* validation, or additional technical data or information, as deemed appropriate by the *competent authority*.
- (i) Description of the *packaging* by reference to the drawings or a specification of the *design*. If deemed appropriate by the *competent authority*, a reproducible illustration not larger than 21 cm × 30 cm, showing the make-up of the *package*, should also be provided, accompanied by a brief description of the *packaging*, including materials of manufacture, gross mass, general external dimensions and appearance.

- (j) A specification of the authorized *radioactive contents*, including any restrictions on the *radioactive contents* that might not be obvious from the nature of the *packaging*. This shall include the physical and chemical forms, the activities involved (including those of the various isotopes, if appropriate), mass in grams (for *fissile material* or for each *fissile nuclide*, when appropriate) and whether *special form radioactive material*, *low dispersible radioactive material* or *fissile material* excepted under para. 417(f), if applicable.
- (k) Additionally, for *packages* containing *fissile material*:
  - (i) A detailed description of the authorized *radioactive contents*;
  - (ii) The value of the *CSI* ;
  - (iii) Reference to the documentation that demonstrates the criticality safety of the *contentspackage*;
  - (iv) Any special features on the basis of which the absence of water from certain void spaces has been assumed in the criticality assessment;
  - (v) Any allowance (based on para. 677(b)) for a change in neutron multiplication assumed in the criticality assessment as a result of actual irradiation experience;
  - (vi) The ambient temperature range for which the special arrangement has been approved.
- (l) A detailed listing of any supplementary operational controls required for preparation, loading, carriage, unloading and handling of the *consignment*, including any special stowage provisions for the safe dissipation of heat.
- (m) If deemed appropriate by the *competent authority*, reasons for the *special arrangement*.
- (n) Description of the compensatory measures to be applied as a result of the *shipment* being under *special arrangement*.
- (o) Reference to information provided by the applicant relating to the use of the *packaging* or specific actions to be taken prior to the *shipment*.
- (p) A statement regarding the ambient conditions assumed for purposes of *design* if these are not in accordance with those specified in paras 656, 657 and 666, as applicable.
- (q) Any emergency arrangements deemed necessary by the *competent authority*.

- (r) A specification of the applicable *management system*, as required in para. 306.
- (s) If deemed appropriate by the *competent authority*, reference to the identity of the applicant and to the identity of the *carrier*.
- (t) Signature and identification of the certifying official.

### **Certificates of approval for Shipments**

837. Each certificate of *approval* for a *shipment* issued by a *competent authority* shall include the following information:

- (a) Type of certificate.
- (b) The *competent authority* identification mark(s).
- (c) The issue date and an expiry date.
- (d) List of applicable national and international regulations, including the edition of the IAEA Regulations for the Safe Transport of Radioactive Material under which the *shipment* is approved.
- (e) Any restrictions on the modes of transport, type of *conveyance*, *freight container* and any necessary routeing instructions.
- (f) The following statement: “This certificate does not relieve the *consignor* from compliance with any requirement of the government of any country *through or into* which the *package* will be transported”.
- (g) A detailed listing of any supplementary operational controls required for preparation, loading, carriage, unloading and handling of the *consignment*, including any special stowage provisions for the safe dissipation of heat or maintenance of criticality safety.
- (h) Reference to information provided by the applicant relating to specific actions to be taken prior to *shipment*.
- (i) Reference to the applicable certificate(s) of *approval of design*.
- (j) A specification of the actual *radioactive contents*, including any restrictions on the *radioactive contents* that might not be obvious from the nature of the *packaging*. This shall include the physical and chemical forms, the total activities involved (including those of the various isotopes, if appropriate), mass in grams (for *fissile material* or for each *fissile nuclide*, when appropriate) and whether *special form*

*radioactive material, low dispersible radioactive material or fissile material* excepted under para. 417(f), if applicable.

- (k) Any emergency arrangements deemed necessary by the *competent authority*.
- (l) A specification of the applicable *management system*, as required in para. 306.
- (m) If deemed appropriate by the *competent authority*, reference to the identity of the applicant.
- (n) Signature and identification of the certifying official.

### **Certificates of approval for package design**

838. Each certificate of *approval* of the *design* of a *package* issued by a *competent authority* shall include the following information:

- (a) Type of certificate.
- (b) The *competent authority* identification mark.
- (c) The issue date and an expiry date.
- (d) Any restriction on the modes of transport, if appropriate.
- (e) List of applicable national and international regulations, including the edition of the IAEA Regulations for the Safe Transport of Radioactive Material under which the *design* is approved.
- (f) The following statement: “This certificate does not relieve the *consignor* from compliance with any requirement of the government of any country *through or into* which the *package* will be transported”.
- (g) References to certificates for alternative *radioactive contents*, other *competent authority* validation, or additional technical data or information, as deemed appropriate by the *competent authority*.
- (h) A statement authorizing *shipment*, where *approval of shipment* is required under para. 825, if deemed appropriate.
- (i) Identification of the *packaging*.
- (j) Description of the *packaging* by reference to the drawings or specification of the *design*. If deemed appropriate by the *competent authority*, a reproducible illustration not larger than 21 cm × 30 cm, showing the make-up of the *package*, should also be provided, accompanied by a brief description of the *packaging*,

including materials of manufacture, gross mass, general external dimensions and appearance.

- (k) Specification of the *design* by reference to the drawings.
- (l) A specification of the authorized *radioactive contents*, including any restrictions on the *radioactive contents* that might not be obvious from the nature of the *packaging*. This shall include the physical and chemical forms, the activities involved (including those of the various isotopes, if appropriate), the mass in grams (for *fissile material*, the total mass of *fissile nuclides* or the mass for each *fissile nuclide*, when appropriate) and whether *special form radioactive material*, *low dispersible radioactive material* or *Fissile material* excepted under para. 417(f), if applicable.
- (m) A description of the *containment system*.
- (n) For *package designs* containing *fissile material* that require *multilateral approval* of the *package design* in accordance with para. 814:
  - (i) A detailed description of the authorized *radioactive contents*;
  - (ii) A description of the *confinement system*;
  - (iii) The value of the *CSI* ;
  - (iv) Reference to the documentation that demonstrates the criticality safety of the ~~contents~~*package*;
  - (v) Any special features on the basis of which the absence of water from certain void spaces has been assumed in the criticality assessment;
  - (vi) Any allowance (based on para. 677(b)) for a change in neutron multiplication assumed in the criticality assessment as a result of actual irradiation experience;
  - (vii) The ambient temperature range for which the *package design* has been approved.
- (o) For *Type B(M) packages*, a statement specifying those prescriptions of paras 639, 655–657 and 660–666 with which the *package* does not conform and any amplifying information that may be useful to other *competent authorities*.

(o)bis For *package designs* subject to para. 820 or 820bis, a statement specifying those requirements of the current regulations with which the package does not conform.

- (p) For *packages* containing more than 0.1 kg of uranium hexafluoride, a statement specifying those prescriptions of para. 634 that apply, if any, and any amplifying information that may be useful to other *competent authorities*.
- (q) A detailed listing of any supplementary operational controls required for preparation, loading, carriage, unloading and handling of the *consignment*, including any special stowage provisions for the safe dissipation of heat.
- (r) Reference to information provided by the applicant relating to the use of the *packaging* or to specific actions to be taken prior to *shipment*.
- (s) A statement regarding the ambient conditions assumed for purposes of *design*, if these are not in accordance with those specified in paras 656, 657 and 666, as applicable.
- (t) A specification of the applicable *management system*, as required in para. 306.
- (u) Any emergency arrangements deemed necessary by the *competent authority*.
- (v) If deemed appropriate by the *competent authority*, reference to the identity of the applicant.
- (w) Signature and identification of the certifying official.

**Certificates of approval for alternative activity limits for an exempt consignment of instruments or articles**

839. Each certificate issued by a *competent authority* for alternative activity limits for an exempt *consignment* of instruments or articles according to para. 818 shall include the following information:

- (a) Type of certificate;
- (b) The *competent authority* identification mark;
- (c) The issue date and an expiry date;
- (d) List of applicable national and international regulations, including the edition of the IAEA Regulations for the Safe Transport of Radioactive Material under which the exemption is approved;
- (e) The identification of the instrument or article;
- (f) A description of the instrument or article;
- (g) *Design* specifications for the instrument or article;

- (h) A specification of the radionuclide(s) and the approved alternative activity limit(s) for the exempt *consignment(s)* of the instrument(s) or article(s);
- (i) Reference to documentation that demonstrates compliance with para. 403(b);
- (j) If deemed appropriate by the *competent authority*, reference to the identity of the applicant;
- (k) Signature and identification of the certifying official.

#### VALIDATION OF CERTIFICATES

840. *Multilateral approval* may be by validation of the original certificate issued by the *competent authority* of the country of origin of the *design* or *shipment*. Such validation may take the form of an endorsement on the original certificate or the issuance of a separate endorsement, annex, supplement, etc., by the *competent authority* of the country *through or into* which the *shipment* is made.

## REFERENCES

References are to editions that are current as of the time of publication of these Regulations. Editions that supersede these may be adopted under national legislation.

- [1] EUROPEAN ATOMIC ENERGY COMMUNITY, FOOD AND AGRICULTURE ORGANIZATION OF THE UNITED NATIONS, INTERNATIONAL ATOMIC ENERGY AGENCY, INTERNATIONAL LABOUR ORGANIZATION, INTERNATIONAL MARITIME ORGANIZATION, OECD NUCLEAR ENERGY AGENCY, PAN AMERICAN HEALTH ORGANIZATION, UNITED NATIONS ENVIRONMENT PROGRAMME, WORLD HEALTH ORGANIZATION, *Fundamental Safety Principles*, IAEA Safety Standards Series No. SF-1, IAEA, Vienna (2006).
- [2] ~~EUROPEAN COMMISSION, FOOD AND AGRICULTURE ORGANIZATION OF THE UNITED NATIONS, INTERNATIONAL ATOMIC ENERGY AGENCY, INTERNATIONAL LABOUR ORGANIZATION, OECD NUCLEAR ENERGY AGENCY, PAN AMERICAN HEALTH ORGANIZATION, UNITED NATIONS ENVIRONMENT PROGRAMME, WORLD HEALTH ORGANIZATION~~ FOOD AND AGRICULTURE ORGANIZATION OF THE UNITED NATIONS, INTERNATIONAL ATOMIC ENERGY AGENCY, INTERNATIONAL LABOUR ORGANISATION, OECD NUCLEAR ENERGY AGENCY, PAN AMERICAN HEALTH ORGANIZATION, WORLD HEALTH ORGANIZATION *Radiation Protection and Safety of Radiation Sources: International Basic Safety Standards Series No. GSR Part 3, –International Basic Safety Standards for Protection against Ionizing Radiation and for the Safety of Radiation Sources, Safety Series No. 115*, IAEA, Vienna (2014)996).
- [3] INTERNATIONAL ATOMIC ENERGY AGENCY, Advisory Material for the IAEA Regulations for the Safe Transport of Radioactive Material (2012 Edition), Series No. SSG-26, Advisory Material for the IAEA Regulations for the Safe Transport of Radioactive Material, IAEA Safety Standards Series No. TS-G-1.1 (Rev. 1), IAEA, Vienna (2014)2008).
- [4] INTERNATIONAL ATOMIC ENERGY AGENCY, *Planning and Preparing for Emergency Response to Transport Accidents Involving Radioactive material*, IAEA Safety Standards Series No. TS-G-1.2 (ST-3), IAEA, Vienna (2002).
- [5] INTERNATIONAL ATOMIC ENERGY AGENCY, *Compliance assurance for the Safe Transport of Radioactive material*, IAEA Safety Standards Series No. TS-G-1.5, IAEA, Vienna (2009).
- [6] INTERNATIONAL ATOMIC ENERGY AGENCY, *The Management System for the Safe Transport of Radioactive material*, IAEA Safety Standards Series No. TS-G-1.4, IAEA, Vienna (2008).
- [7] INTERNATIONAL ATOMIC ENERGY AGENCY, *Radiation protection programmes for the Transport of Radioactive material*, IAEA Safety Standards Series No. TS-G-1.3, IAEA, Vienna (2007).
- [8] INTERNATIONAL MARITIME ORGANIZATION, *International Maritime Dangerous Goods (IMDG) Code*, IMO, London (2010).
- [9] INTERNATIONAL ORGANIZATION FOR STANDARDIZATION, *Radiation Protection — Sealed Radioactive Sources — Leakage Test Methods*, ISO 9978:1992(E),

ISO, Geneva (1992).

- [10] UNITED NATIONS, Recommendations on the Transport of Dangerous Goods, Model Regulations, ST/SG/AC.10/1/Rev.17, UN, New York and Geneva (2011).
- [11] INTERNATIONAL ORGANIZATION FOR STANDARDIZATION, Series 1 *Freight containers* — Specifications and Testing – Part 1: General Cargo Containers for General Purposes, ISO 1496:1990(E), ISO, Geneva (1990); and subsequent Amendments 1:1993, 2:1998, 3:2005, 4:2006 and 5:2006.
- [12] INTERNATIONAL ORGANIZATION FOR STANDARDIZATION, Nuclear Energy — *Packaging of Uranium Hexafluoride (UF<sub>6</sub>) for Transport*, ISO 7195:2005(E), ISO, Geneva (2005).
- [13] INTERNATIONAL ORGANIZATION FOR STANDARDIZATION, Radiation Protection — Sealed Radioactive Sources — General Requirements and Classification, ISO 2919:2012(E), ISO, Geneva (2012).
- [14] FAO, IAEA, ICAO, ILO, IMO, INTERPOL, OECD/NEA, PAHO, CTBTO, UNEP, OCHA, WHO, WMO, Preparedness and Response for a Nuclear or Radiological Emergency, Series No. GSR Part 7, IAEA, Vienna (2015).
- [15] INTERNATIONAL ATOMIC ENERGY AGENCY, Criteria for Use in Preparedness and Response for a Nuclear or Radiological Emergency, Series No.GSG-2, IAEA, Vienna (2011).
- [16] INTERNATIONAL ATOMIC ENERGY AGENCY, Arrangements for Preparedness for a Nuclear or Radiological Emergency, Series No.GS-G-2.1, IAEA, Vienna (2007).
- [17] INTERNATIONAL ATOMIC ENERGY AGENCY, Schedules of Provisions of the IAEA Regulations for the Safe Transport of Radioactive Material (2012 Edition) Series No. SSG-33, IAEA, Vienna (2015).
- [18] INTERNATIONAL ATOMIC ENERGY AGENCY, Governmental, Legal and Regulatory Framework for Safety, Series No. GSR Part 1 (Rev. 1), IAEA, Vienna (2016)
- [19] INTERNATIONAL ATOMIC ENERGY AGENCY, Leadership and Management for Safety, Draft General Safety Requirements, Series No. GSR Part 2, DS456 (under development)

## Annex I

### SUMMARY OF APPROVAL AND PRIOR NOTIFICATION REQUIREMENTS

This summary reflects the contents of the Regulations for the Safe Transport of Radioactive Material (2012 Edition). The user's attention is called to the fact that there may be deviations (exceptions, additions, etc.) relative to:

- (a) National regulations relating to safety;
- (b) *Carrier* restrictions;
- (c) National regulations relating to security, physical protection, liability, insurance, pre-notification and/or routing and import/export/transit licensing.<sup>1</sup>

---

<sup>1</sup> In particular, additional measures are taken to provide appropriate physical protection in the transport of nuclear material and to prevent acts without lawful authority that constitute the receipt, possession, use, transfer, alteration, disposal or dispersal of nuclear material and which cause or are likely to cause, death or serious injury to any person or substantial damage to property (see Refs I-1 to I-6).

ANNEX I: SUMMARY OF APPROVAL AND PRIOR NOTIFICATION REQUIREMENTS (Part 1)

Key paragraphs in the Regulations	Class of <i>package</i> or material	Competent authority approval required		Consignor required to notify country of origin and countries en route <sup>a</sup> of each
		Country of origin	Countries en route <sup>a</sup>	
	<i>Excepted package</i> <sup>b,c</sup>	No	No	No
	<i>LSA material</i> <sup>c,d,e</sup> and <i>SCO-I</i> <sup>c,e</sup> and <i>SCO-II</i> <sup>c,e</sup> — Type <i>IP-1</i> , — Type <i>IP-2</i> or — Type <i>IP-3</i>	No	No	No
<u>520, 825</u>	<u><i>SCO-III</i></u> <u>— <i>Shipment</i></u>	<u>Yes</u>	<u>Yes</u>	<u>Yes</u>
	<i>Type A</i> <sup>c,d,e</sup>	No	No	No

<sup>a</sup> Countries *Through or into* which (but not over which) the *consignment* is transported (see para. 204 of the Regulations).

<sup>b</sup> For international transport by post, the *consignment* shall be deposited with the postal service only by *consignors* authorized by the national authority.

<sup>c</sup> If the *Radioactive contents* are *Fissile material* excepted under para. 417(f) of the Regulations, *multilateral approval* shall be required (see para. 805 of the Regulations).

<sup>d</sup> If the *Radioactive contents* are uranium hexafluoride in quantities of 0.1 kg or more, the *approval* requirements for *packages* containing it shall additionally apply (see paras 802 and 807 of the Regulations).

<sup>e</sup> If the *Radioactive contents* are *Fissile material* that is not excepted from the requirements for *packages* containing *fissile material*, then the *approval* requirements in paras 814 and 825 of the Regulations shall additionally apply.

ANNEX I: SUMMARY OF APPROVAL AND PRIOR NOTIFICATION REQUIREMENTS (Part 2)

Key paragraphs in the Regulations	Class of <i>package</i> or material	Competent authority approval required		Consignor required to notify country of origin and countries en route <sup>a</sup> of each <i>Shipment</i>
		Country of origin	Countries en route <sup>a</sup>	
	<i>Type B(U)</i> <sup>b,c,d</sup>			
808	— <i>Package design</i>	Yes	No <sup>e</sup>	
557, 558, 825	— <i>Shipment</i>	No	No	(see Notes 1 and 2)
	<i>Type B(M)</i> <sup>b,c,e</sup>			
811	— <i>Package design</i>	Yes	Yes	Yes
557, 558, 825	— <i>Shipment</i>	(see Note 3)	(see Note 3)	(see Note 1)
	<i>Type C</i> <sup>b,c,d</sup>			
808	— <i>Package design</i>	Yes	No	
557, 558, 825	— <i>Shipment</i>	No	No	(see Notes 1 and 2)

<sup>a</sup> Countries *Through or into* which (but not over which) the *consignment* is transported (see para. 204 of the Regulations).

<sup>b</sup> If the *Radioactive contents* are *Fissile material* that is not excepted from the requirements for *packages* containing *fissile material*, then the *approval* requirements in paras 814 and 825 of the Regulations shall additionally apply.

<sup>c</sup> If the *Radioactive contents* are uranium hexafluoride in quantities of 0.1 kg or more, the *approval* requirements for *packages* containing it shall additionally apply (see paras 802 and 807 of the Regulations).

<sup>d</sup> If the *Radioactive contents* are *Fissile material* excepted under para. 417(f) of the Regulations, *multilateral approval* shall be required (see para. 805 of the Regulations).

<sup>e</sup> If the *Radioactive contents* are *low dispersible radioactive material* and the *package* is to be shipped by air, *multilateral approval* of the *package design* is required (see para. 808(b) of the Regulations).

**Note 1:** Before the first *Shipment* of any *package* requiring *competent authority approval* of the *design*, the *consignor* shall ensure that a copy of the certificate of *approval* for that *design* has been submitted to the *competent authority* of each country (see para. 557 of the Regulations).

**Note 2:** Notification is required if the *Radioactive contents* exceed 3000A1, or 3000A2, or 1000 TBq, whichever is the lower (see para. 558 of the Regulations).

**Note 3:** *Multilateral approval* of *Shipment* required if the *Radioactive contents* exceed 3000A1, or 3000A2, or 1000 TBq, whichever is the lower, or if controlled intermittent venting is allowed (see para. 825 of the Regulations).

ANNEX I: SUMMARY OF APPROVAL AND PRIOR NOTIFICATION REQUIREMENTS (Part 3)

Key paragraph in the Regulations	Class of <i>package</i> or material	Competent authority approval required		Consignor required to notify country of origin and countries en route <sup>a</sup> of each <i>Shipment</i>
		Country of origin	Countries en route <sup>a</sup>	
	<i>Packages for fissile material</i>			
814	— <i>Package design</i>	Yes <sup>b</sup>	Yes <sup>b</sup>	
825	— <i>Shipment</i>			
	ΣCSI ≤ 50	No <sup>c</sup>	No <sup>c</sup>	(see Notes 1 and 2)
	ΣCSI > 50	Yes	Yes	(see Notes 1 and 2)
	<i>Packages containing 0.1 kg or more of uranium hexafluoride<sup>d</sup></i>			
807	— <i>Package design</i>	Yes	Yes for H(M)/no for H(U)	
825	— <i>Shipment</i>	No <sup>c</sup>	No <sup>c</sup>	(see Notes 1 and 2)

<sup>a</sup> Countries *Through or into* which (but not over which) the *consignment* is transported (see para. 204 of the Regulations).

<sup>b</sup> *Designs of packages containing Fissile material* may also require *approval* in respect of one of the other items in Annex I.

<sup>c</sup> *Shipments* may, however, require *approval* in respect of one of the other items in Annex I.

<sup>d</sup> If the *Radioactive contents* are *Fissile material* excepted under para. 417(f) of the Regulations, *multilateral approval* shall be required (see para. 805 of the Regulations).

**Note 1:** The *multilateral approval* requirement for *fissile packages* and some uranium hexafluoride *packages* automatically satisfies the requirement of para. 557 of the Regulations.

**Note 2:** Notification is required if the *Radioactive contents* exceed 3000A1, or 3000A2, or 1000 TBq, whichever is the lower (see para. 558 of the Regulations).

ANNEX I: SUMMARY OF APPROVAL AND PRIOR NOTIFICATION REQUIREMENTS (Part 4)

Key paragraphs in the Regulations	Class of <i>package</i> or material	Competent authority approval required		Consignor required to notify country of origin and countries en route <sup>a</sup> of each <i>Shipment</i>
		Country of origin	Countries en route <sup>a</sup>	
803 825	<i>Special form radioactive material</i> — <i>Design</i> — <i>Shipment</i>	Yes (see Note 1)	No (see Note 1)	No (see Note 1)
803 825	<i>Low dispersible radioactive material</i> — <i>Design</i> — <i>Shipment</i>	Yes (see Note 1)	Yes (see Note 1)	No (see Note 1)
558, 802, 829	<i>Special arrangement</i> — <i>Shipment</i> <i>Type B (U) packages</i> for which <i>design</i> is approved under	Yes	Yes	Yes
820	— 1973 Regulations	Yes	Yes	(see Note 2)
820	— 1985 Regulations <i>Fissile material</i> excepted from	Yes	Yes	(see Note 2)
805	“FISSILE” classification, in accordance with para. 606	Yes	Yes	No
817	Exempt <i>consignment</i> of instruments or articles	Yes	Yes	No

<sup>a</sup> Countries *Through or into* which (but not over which) the *consignment* is transported (see para. 204 of the Regulations).

**Note 1:** See *approval* and prior notification requirements for applicable *package*.

**Note 2:** Before the first *Shipment* of any *package* requiring *competent authority approval* of the *design*, the *consignor* shall ensure that a copy of the certificate of *approval* for that *design* has been submitted to the *competent authority* of each country (see para. 557 of the Regulations).

## REFERENCES TO ANNEX I

- [I-1] INTERNATIONAL ATOMIC ENERGY AGENCY, The Convention on the Physical Protection of Nuclear Material, INFCIRC/274/Rev.1, IAEA, Vienna (1980).
- [I-2] INTERNATIONAL ATOMIC ENERGY AGENCY, Nuclear Security Recommendations on Physical Protection of Nuclear Material and Nuclear Facilities (INFCIRC/225/Revision 5), IAEA Nuclear Security Series No. 13, IAEA, Vienna (2011).
- [I-3] INTERNATIONAL ATOMIC ENERGY AGENCY, Guidance and Considerations for the Implementation of INFCIRC/225/Rev.4, The Physical Protection of Nuclear Material and Nuclear Facilities, IAEA-TECDOC-967(Rev.1), IAEA, Vienna (2000).
- [I-4] INTERNATIONAL ATOMIC ENERGY AGENCY, Security in the Transport of *Radioactive material*, IAEA Nuclear Security Series No. 9, IAEA, Vienna (2008).
- [I-5] INTERNATIONAL ATOMIC ENERGY AGENCY, Code of Conduct on the Safety and Security of Radioactive Sources, IAEA, Vienna (2004).
- [I-6] INTERNATIONAL ATOMIC ENERGY AGENCY, Guidance on the Import and Export of Radioactive Sources, IAEA, Vienna (2005).
- [I-7] INTERNATIONAL ATOMIC ENERGY AGENCY. Convention on the Physical Protection of Nuclear Material and Nuclear Facilities, Amendment to the Convention on the Physical Protection of Nuclear Material



## Annex II

### CONVERSION FACTORS AND PREFIXES

This edition of the Regulations for the Safe Transport of Radioactive Material uses the International System of Units (SI). The conversion factors for non-SI units are:

#### RADIATION UNITS

Activity in becquerel (Bq) or curie (Ci)

$$1 \text{ Ci} = 3.7 \times 10^{10} \text{ Bq}$$

$$1 \text{ Bq} = 2.7 \times 10^{-11} \text{ Ci}$$

Dose equivalent in sievert (Sv) or rem

$$1 \text{ rem} = 1.0 \times 10^{-2} \text{ Sv}$$

$$1 \text{ Sv} = 100 \text{ rem}$$

#### PRESSURE

Pressure in pascal (Pa) or (kgf/cm<sup>2</sup>)

$$1 \text{ kgf/cm}^2 = 9.806\,808 \times 10^4 \text{ Pa}$$

$$1 \text{ Pa} = 1.020 \times 10^{-5} \text{ kgf/cm}^2$$

#### CONDUCTIVITY

Conductivity in siemens per metre (S/m) or (mho/cm)

$$10 \text{ } \mu\text{mho/cm} = 1 \text{ mS/m or}$$

$$1 \text{ mho/cm} = 100 \text{ S/m}$$

$$1 \text{ S/m} = 10^{-2} \text{ mho/cm}$$

## SI PREFIXES AND SYMBOLS

The decimal multiples and submultiples of a unit may be formed by prefixes or symbols, having the following meanings, placed before the name or symbol of the unit:

Multiplying factor	Prefix	Symbol
$1\ 000\ 000\ 000\ 000\ 000\ 000 = 10^{18}$	exa	E
$1\ 000\ 000\ 000\ 000\ 000 = 10^{15}$	peta	P
$1\ 000\ 000\ 000\ 000 = 10^{12}$	tera	T
$1\ 000\ 000\ 000 = 10^9$	giga	G
$1\ 000\ 000 = 10^6$	mega	M
$1\ 000 = 10^3$	kilo	k
$100 = 10^2$	hecto	h
$10 = 10^1$	deca	da
$0.1 = 10^{-1}$	deci	d
$0.01 = 10^{-2}$	centi	c
$0.001 = 10^{-3}$	milli	m
$0.000\ 001 = 10^{-6}$	micro	$\mu$
$0.000\ 000\ 001 = 10^{-9}$	nano	n
$0.000\ 000\ 000\ 001 = 10^{-12}$	pico	p
$0.000\ 000\ 000\ 000\ 001 = 10^{-15}$	femto	f
$0.000\ 000\ 000\ 000\ 000\ 001 = 10^{-18}$	atto	a

### Annex III

#### SUMMARY OF *CONSIGNMENTS REQUIRING EXCLUSIVE USE*

The following *consignments* are required to be shipped under *exclusive use*:

- (a) Unpackaged *LSA-I* material, ~~and *SCO-I* and *SCO-III*~~ (see para. 520);
- (b) Liquid *LSA-I* material in a *Type IP-1 package* (see para. 521 and Table 5); (c) Gaseous and/or liquid *LSA-II* material in a *Type IP-2 package* (see para. 521 and Table 5);
- (d) *LSA-III* material in a *Type IP-2 package* (see para. 521 and Table 5);
- (e) *Packages* or *Overpacks* having an individual *TI* greater than 10 or a *consignment CSI* greater than 50 (see paras 526 and 567);
- (f) *Packages* or *Overpacks* having the maximum *radiation level* at any point on the external surfaces that exceed 2 mSv/h (see para. 527);
- (g) Loaded *conveyance* or *large freight containers* with a total sum of *TI* exceeding the values given in Table 10 (see para. 566(a));
- (h) Loaded *conveyances* or *large freight containers* with a total sum of *CSI* exceeding the values given in Table 11 for “not under *exclusive use*” (see para. 569);
- (i) *Type B(U)*, *Type B(M)* or *Type C package* whose temperature of accessible surfaces exceeds 50°C when subject to an ambient temperature of 38°C in the absence of insolation (see para. 654);
- (j) Up to 45 g of *fissile nuclides* on a *conveyance*, either packaged or unpackaged, in accordance with the provisions of paras 417(e) and 520(d);
- (k) *Packages* containing *fissile material* classified as non-fissile or fissile-excepted under para. 417(a)(i) or (iii) of the 2009 Edition of these Regulations (see para. 822).